



PLAYPARC

Mehr Spielraum für {Bewegung}

In vier Geschäftsbereichen bietet PLAYPARC individuelle und standardisierte Lösungen.

In four business units PLAYPARC offers individual and standard solutions.

SPIELPLATZ

FITNESS

URBANPARC®

ERSATZTEILE



Kataloge und Produktinformationen finden Sie hier zum Download.

Catalogues and product information can be downloaded here.

PLAYPARC

Allwetter-Freizeit-Anlagenbau GmbH
Zur Kohlstätte 9, D-33014 Bad Driburg

✉ info@playparc.de

☎ +49 (0) 5253/40599-0

🌐 playparc.de



KATALOG CATALOGUE

PLAYPARC

KATALOG
CATALOGUE



PLAYPARC



WILLKOMMEN

WIR BRINGEN MENSCHEN IN BEWEGUNG



In vier Geschäftsbereichen bieten wir individuelle und standardisierte Lösungen.

SPIELPLATZ

FITNESS

URBANPARC®

ERSATZTEILE



PLAYPARC

Mehr Spielraum für {Bewegung}

Herzlich Willkommen in den PLAYPARC Bewegungs- und Erlebniswelten. Bewegung ist gut und Bewegung tut gut. Je nach Alter bewegt der Mensch sich anders, hat andere Motivationen und Bedürfnisse für Bewegung. In diesem PLAYPARC-Katalog präsentieren wir Ihnen viele Neuentwicklungen und Bewährtes.

Mit unseren Produkten und Konzepten tragen wir dazu bei, dass Kinder sich durch Spiel und Bewegung entwickeln können, Jugendliche im öffentlichen Raum attraktive Aufenthaltsangebote erhalten und Erwachsene sinnvolle Bewegungsangebote vorfinden.

Wir helfen Ihnen, die Menschen ein kleines bisschen beweglicher, verspielter und vielleicht sogar glücklicher zu machen.

Ihre Familie Strasser

Siegfried und Steffen Strasser
Gründer und Geschäftsführer
PLAYPARC



MADE IN GERMANY

Welcome to the PLAYPARC movement and experience worlds. Movement is good for mind and body. Depending on age, people move differently, have different motivations and needs for movement. In this PLAYPARC catalog, we present many new developments and proven products.

With our products and concepts, we help children to develop through play and exercise, young people to receive attractive recreational opportunities in public spaces and adults to find meaningful exercise opportunities.

We help you to make people a little more agile, playful and perhaps even happier.

Your family Strasser

Siegfried and Steffen Strasser
Founder and Managing Director
PLAYPARC

WELCOME

WE GET PEOPLE ON THE MOVE



Inhaltsangabe Site map

10-23	INSPIRATIONEN	INSPIRATIONS
24-141	SPIEL + BEWEGUNG PLAY + MOVEMENT	
24-25	NEOLINI	Vertikales Spielraum-Konzept Vertical playground concept
26-31	KIT+ SYSTEM	Modulares Multi-Spielplatzsystem Modular multi-playground system
32-37	HARENA	Sandspielgeräte Sandplay equipment
38-45	ETOLIS®	Multi-Spielplatz Multi-playground
46-47	FRISIA	Balancier-Parcours Balancing parcours
48-59	BALANCE	Balancier-Systeme Balancing systems
60-65	EXPERIMENT	Sinnesspiel + Musik Sensual play + music
66-97	BASICS	Spielplatzklassiker Classical play equipment
98-111	MULTI-SPIEL	Spielplatzhighlights Playground highlights
112-129	NETZ	Netzwelten Net worlds
130-139	SPORT	Kinderspielplatz-Sportgeräte Playground sports equipment
140-141	MOBILIAR	Kinderspielplatz-Mobiliar Playground furniture
142-193	FITNESS + SPORT	FITNESS + SPORTS
144-145	FITNESSBANK	Trainings- und Sitzbank Training and relax bench
146-165	4FCIRCLE®	Kraft, Ausdauer, Koordination, Mobilisation Power, Endurance, Coordination, Mobilisation
166-181	CALISTHENICS	Outdoor Trendsportgeräte Outdoor trendsport stations
182-183	4F SCHILDER	Hinweis- und Übungsschilder / Wetterschutz Instruction and exercise signs / rain shelter
184-185	MOBILPARC®	Mobiles Outdoor-Fitnessstudio Mobile outdoor gym
186-189	PARKOUR	Parkour-Anlagen Parkour facilities
190-193	OCR	Extrem-Hindernisrennen Obstacle course racing
194-203	URBANPARC®	Stadt- und Parkmöbel City and park furniture
204-207	INFORMATION	AGBs Terms of Trade
208-209	KONTAKT UND GEWÄHRLEISTUNGEN	CONTACT AND WARRANTIES



ÜBER PLAYPARC

ABOUT PLAYPARC

Seit **1979** konzeptioniert, realisiert und errichtet PLAYPARC Spielplätze und Sportanlagen für den öffentlichen Raum - seit 2014 Calisthenics-Anlagen in der ganzen Welt.

Since **1979** PLAYPARC has been designing, implementing and constructing playgrounds and sports facilities for public spaces - since 2014 Calisthenics plants all over the world.

In **25 Ländern** pflegt PLAYPARC Partnerschaften um weltweit für seine Kunden da zu sein.

In **25 countries** PLAYPARC maintains partnerships to be there for its customers worldwide.



UNSERE PARTNER

OUR PARTNERS



allgemeiner deutscher
hochschulsportverband



Über **500 Jahre Erfahrung** haben sich in Summe in der PLAYPARC-Familie im Laufe der Jahre angesammelt, die jeden Tag genutzt werden können. Jedes Mitglied trägt mit seinem Wissen, seiner Erfahrung und seiner Persönlichkeit zum Erfolg des Unternehmens bei.

More than **500 years of experience** have accumulated in the PLAYPARC family over the years, which can be used every day. Each member contributes with his/her knowledge, experience and personality to the success of the company.

SYMBOLE

SYMBOLS



Symbolerklärung

Definition of symbols

- = **Maße/Platzbedarf** Dimensions
- = **Fallraum** Falling area
- = **max. freie Fallhöhe** Max. free fall height
- = **Gesamthöhe** Total height
- = **Fertigfundament** Ready-to-install foundation
- = **Altersgruppe** Age group
- = **U3 Spielgeräte** U-3 Play Equipment
- = **Kindergarten** Kindergarten
- = **Schule** School
- = **Teens** Teens
- = **Inklusion** Inclusion
- = **Frei von** polyzyklischen, aromatischen Kohlenwasserstoffen
Free of polycyclic aromatic hydrocarbons





SO FUNKTIONIERT INKLUSION

BARRIEREFREIE PLANUNG UND GERÄTE

INCLUSION WORKS THIS WAY

BARRIER-FREE PLANNING AND EQUIPMENT



So funktioniert Inklusion

Trotz körperlicher Einschränkung 100%iger Spielspaß

Kinder mit Einschränkungen sollen in die Gesellschaft einbezogen und als vollwertiger Mensch wahrgenommen werden.

Spielerisch lernen die Kinder miteinander umzugehen und einander zu respektieren.

Keiner möchte isoliert auf einem abgesonderten „Behinderten-Spielplatz“ ausgegrenzt werden. Unser Ziel ist es, dass Inklusionsgeräte Teil der herkömmlichen Spielanlage werden. Aus diesem Grund, haben wir uns auch bei der Kataloggestaltung dazu entschieden, das Inklusionsprogramm in das bestehende Sortiment zu integrieren.



Inclusion

100% play value for all

Children with special needs should be integrated completely in the society and in play. In a playful way children learn to respect and treat each other right. Nobody wants to be separated on a special-needs-playground. It is our goal to create inclusive playspaces. This is why we integrated inclusive playitems in our portfolio.

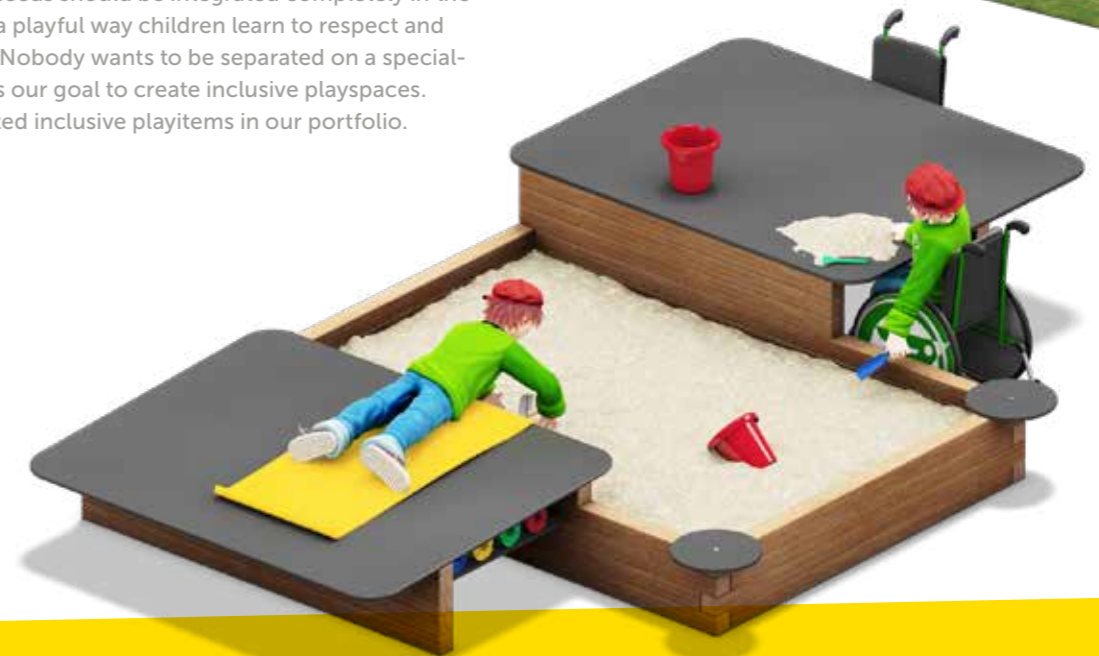
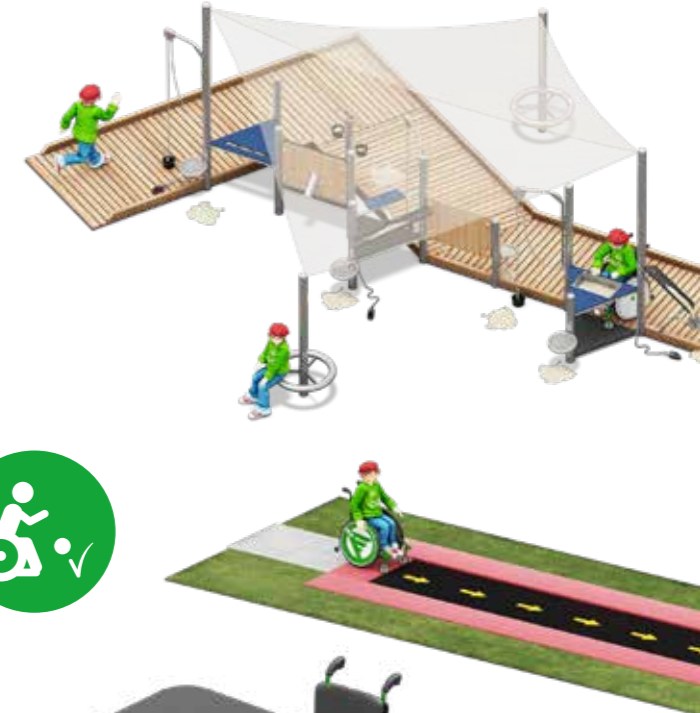



ALTERSGRUPPEN-MATRIX

SPIEL + BEWEGUNG

AGE GROUPS MATRIX

PLAY + MOVEMENT



Produktgruppe	U3	KiGa	Schule	Teens	Twens	Ü30																				
ALTER (JAHRE)	1-3	3-6	7-10	11-14	15-18	19-30	31-50	51-65	66-120																	
Spiel- und Bewegungsmotto	Spiel- und Bewegung in Geborgenheit		Spiel- und Bewegung in Nähe		Spiel- und Bewegung als Befreiung		Spiel und Bewegung in der Freizeit		Bewegung als Lust		Vernunftmäßige Bewegung		Autarkie-Erhalt													
menschliche Bindungen	feste Elternbindung		feste Erwachsenenbindung		Lockerung der Erwachsenenbindung		Testen der Selbstständigkeit		Lösung von Erwachsenenbindung, Anspruch auf Selbstständigkeit		Bindung an Peer-Gruppen		Bindung an gesellschaftliche Normen		starke Differenzierung, teilweise Bindung an „alte“ Werte / Selbstverwirklichung											
Spielverhalten			Bewegungsspiele (Sensomotorik)		Symbolspiel / Rollenspiel		Gruppentreffen / soziale Aspekte		Regelspiele		Wettbewerbsspiele / sich messen		Risikospiel		Kommunikatives Spiel		Präsentationsverhalten									
Institutionen	Kindergarten		Grundschule		weiterführende Schule		Ausbildungsstätten / Unternehmen		Vereine																	
Spiel + Bewegung	NEOSPIEL® Basics		Zwergenland		Wasserspielanlagen		Sandspielanlagen: HARENA		Multispielanlagen: NEOLINI / ETOLIS® / HARENA / Themenspiel		Abenteuer-Parcours: FRISIA / Kiddy Parcours / Safari-Parc / Fun-Run		Kletteranlagen: Seilpyramiden / Komtenschweif / SERPENTES®		Karusselle: LUUPZ® / Hally-Gally / Hip-Hop		Multi-Sportanlagen		4FCIRCLE®		OCR / Parcours		Calisthenics		MOBILPARC®	
Fitness + Sport																										
Außenmobiliar																										

PLAYPARC-ENTWICKLUNGSMATRIX
Wir bei PLAYPARC glauben, dass jeder Mensch sich bewegen will. Unterschiedliche Beweggründe, Spielmotivationen und Fähigkeiten müssen Ihren Ausdruck in individuellen Konzepten finden. Dazu haben wir von PLAYPARC passende Lösungen für jedes Alter entwickelt. DIE PLAYPARC-ENTWICKLUNGSMATRIX GIBT IHNEN EINEN SCHNELLEN ÜBERBLICK.

Product group	U3	Preschool	School	Teens	above 30																					
AGE (YEARS)	1-3	3-6	7-10	11-14	15-18	19-30	31-50	51-65	66-120																	
Play and movement slogan	Security playing age		Proximity playing age		Expansion playing age		Play/movement/recreational youth age		Movement for fun		Rational movement		Self-sufficiency/ Recovery													
Attachment behaviour	Solid bond to parents		Solid bond to adults		Relaxing of the bond to parents, testing of independence		Bond to parents terminated, demand for independence		Bond to peer groups		Bond to social norms		Strong differentiation, partial bond to „old“ values/self-realisation													
Play behaviour			Play to practise sensorimotor skills (movement play)		Symbolic/role play		Play with rules		Group meetings/social aspects		Competition games/competing		Risk play		Communicative play		Presentation behaviour									
Institutions	Preschool		Primary school		Secondary school		Company/vocational training premises		Clubs																	
Play & movement	NEOSPIEL® Basics		Dwarf houses		Water play		Sand play units: HARENA		Multiplay units: NEOLINI, ETOLIS®, HARENA, theme play		Adventure parcours: FRISIA/ Kiddy Parcours / Safari Parc / Fun-Run		Climbing equipment: Rope pyramids, comet tail/ SERPENTES®		Roundabouts: LUUPZ® / Hally-Gally / Hip-Hop		Multi use game areas (MUGAS)		4FCIRCLE®		OCR / Parcours		Calisthenics		MOBILPARC®	
Fitness & Sport																										
Outdoor furniture																										

PLAYPARC-DEVELOPMENT MATRIX
We at PLAYPARC believe that all people want to move. Different reasons, motivations and abilities ask for individual concepts. PLAYPARC has developed solutions for each age group. The PLAYPARC development matrix gives you a quick overview.



Die Altersgruppenmatrix finden Sie hier zum Download.
The age group matrix can be downloaded here.

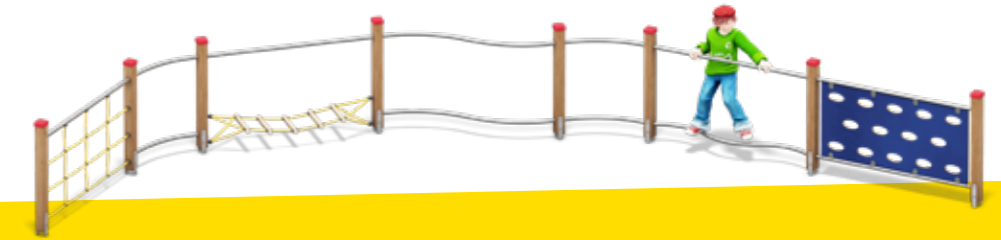



INSPIRATION

GROSSE SPIELPLATZ-ATTRAKTIONEN

INSPIRATION

BIG PLAYGROUND ATTRACTIONS



- | | | |
|----|--|---------|
| 1. | LUUPZ® 6 KARUSSELL PINGUI
LUUPZ® 6 CAROUSEL PINGUI | 66-67 |
| 2. | ETOLIS® MULTI-SPIELPLATZ
ETOLIS® MULTI-PLAYGROUND | 38-45 |
| 3. | SPIELTURM "KATZOHLBACH"
PLAY TOWER "KATZOHLBACH" | 100-101 |
| 4. | BIG LUUPZ® KARUSSELL "TIVAT"
BIG LUUPZ® CAROUSEL "TIVAT" | 68-69 |
| 5. | FALLNIX | 71 |
| 6. | KOMBISCHAUKE MIT VOGELNEST
COMBI SWING WITH BIRDS NEST | 81 |





INSPIRATION

INKLUSIVE SPIELBEREICHE VERBINDEN

INSPIRATION

INCLUSIVE PLAY AREAS CONNECT

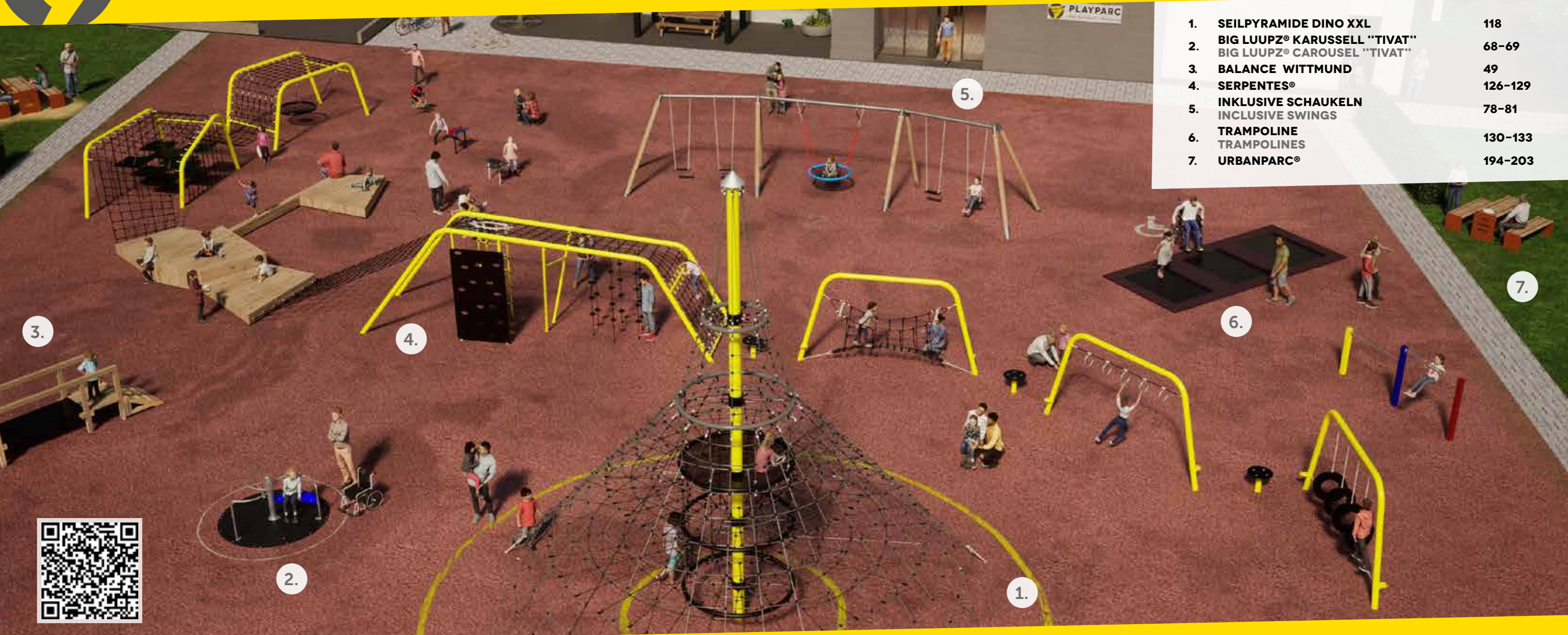

1.	SEILPYRAMIDE DINO XXL	118
2.	BIG LUUPZ® KARUSSELL "TIVAT" BIG LUUPZ® CAROUSEL "TIVAT"	68-69
3.	BALANCE WITTMUND	49
4.	SERPENTES®	126-129
5.	INKLUSIVE SCHAUKELN INCLUSIVE SWINGS	78-81
6.	TRAMPOLINE TRAMPOLINES	130-133
7.	URBANPARC®	194-203





2.

4.

3.

1.

1.	HARENA SANDSPIELGERÄTE HARENA SANDPLAY EQUIPMENT	32-39
2.	WASSERSPIELGERÄTE WATER PLAY EQUIPMENT	64-65
3.	ETOLIS® MULTI-SPIELPLATZ ETOLIS® MULTI-PLAYGROUND	38-45
4.	SONNENSCHUTZ SUN PROTECTION	73



- | | | |
|----|---|----------------|
| 1. | URBANPARC® | 194-203 |
| 2. | BIG LUUPZ® KARUSSELL "TIVAT"
BIG LUUPZ® CAROUSEL "TIVAT" | 68-69 |
| 3. | FITNESSBANK FITNESS BENCH | 144-145 |
| 4. | 4F MOBILISATION | 166-167 |
| 5. | CALISTHENICS | 168-181 |
| 6. | HARENA SANDSPIELGERÄTE
HARENA SAND PLAY UNITS | 32-37 |



INSPIRATION

FANTASIEANREGENDE SPIELPLÄTZE

INSPIRATION

FANTASY-STIMULATING PLAYGROUNDS



1. **ETOLIS® MULTI-SPIELPLATZ FABULA DESIGN**
ETOLIS® MULTI-PLAYGROUND FABULA DESIGN 38-45
2. **BIG LUUPZ® KARUSSELL „BREAKDANCER“**
BIG LUUPZ® CAROUSEL „BREAKDANCER“ 68-69
3. **HARENA SANDSPIELGERÄTE**
HARENA SANDPLAY EQUIPMENT 32-37
4. **SPIELPLATZ-ATTRAKTIONEN**
PLAYGROUND ATTRACTIONS 110-111
5. **SCHAUKELN**
SWINGS 80-81





INSPIRATION

ÖFFENTLICHE OUTDOOR FITNESS FÜR ALLE

INSPIRATION

PUBLIC OUTDOOR FITNESS FOR ALL



1.	FITNESSBANK FITNESS BENCH	144-145
2.	DIPS-BARREN DIPS-BARS	156
3.	CALISTHENICS	166-181
4.	4F KRAFT 4F STRENGTH	156-159
5.	CALISTHENICS ADD-ONS / EXTRAS	181
6.	TRIMMFIT TRAINING ZONE	159



INSPIRATION

URBANER SPIELPLATZ

INSPIRATION

URBAN PLAYGROUND



- | | | |
|----|--|---------|
| 1. | FRISIA BALANCE-PARCOURS
FRISIA BALANCING PARCOURS | 46-47 |
| 2. | LUUPZ® + BIG LUUPZ® KARUSSELLE
LUUPZ® + BIG LUUPZ® CAROUSELS | 68-69 |
| 3. | ETOLIS® MULTI-SPIELPLATZ
ETOLIS® MULTI-PLAYGROUND | 38-45 |
| 4. | JUGENDBANK TEENAGER BENCH | 141 |
| 5. | URBANPARC® | 194-203 |





NEOLINI® - SPIELRAUM KONZEPT

GENIAL VERTIKAL UND MODULAR ERWEITERBAR

NEOLINI® - PLAY SPACE CONCEPT

GENIAL VERTICAL AND MODULARY UPGRADABLE



GENIAL VERTIKAL
SICHER - PLATZSPAREND - MODULAR

GENIAL VERTICAL
SAVE - SPACE OPTIMIZED - MODULAR



In Zusammenarbeit mit pädagogischen Fachkräften haben wir **NEOLINI®** entwickelt und dabei unser langjähriges Wissen über sicheres Spielen und Bewegen in ein innovatives Spielraumkonzept eingebracht, das die (Raum-)Höhe nutzt und dabei wenig Grundfläche und fast keinen Fallschutz benötigt.

Durch die Modulbauweise und Vielfältigkeit in der Gestaltung und Ausstattung ist eine individuelle Konfiguration für jedes Budget und für jeden Raum möglich.

NEOLINI® ist die platzsparende Lösung für robuste und nachhaltige Spielräume im Innen- und Außenbereich, bei der hauptsächlich nachwachsende Rohstoffe sowie langlebige und zu 95% wiederverwertbare Materialien zum Einsatz kommen. Fünf Modelle voller Spielwerte haben wir für typische Raumsituationen vorab zusammengestellt.

In cooperation with educators, we have developed **NEOLINI®** and applied our many years of knowledge about safe play and movement to an innovative playroom concept that uses the (room) height and requires little floor space and no fall protection.

Due to the modular construction and diversity in design and equipment, an individual configuration is possible for every budget and for every room.

NEOLINI® is the space-saving solution for robust and sustainable indoor and outdoor play areas, using mainly renewable raw materials as well as durable and 95% recyclable materials. We have pre-compiled five models full of play value for typical room situations,

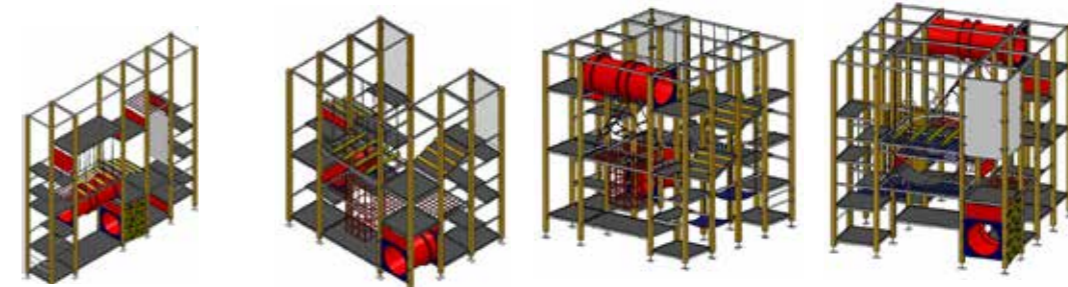

NEOLINI® 1
75.01.021
~ 7 m²

NEOLINI® 2
75.01.022
~ 9 m²

NEOLINI® 3:
75.01.023
~ 16 m²

NEOLINI® 4
75.01.024
~ 16 m²



HARENA
SANDSPIEL SANDPLAY



ETOLIS®
MULTI-SPIEL MULTI-PLAY



FRISIA
BALANCIEREN BALANCING

KIT+ SPIELPLATZBAUKASTEN MIT VIELEN MODULEN

Beim modularen KIT+ System passt alles zusammen und kann miteinander kombiniert werden. Dies ermöglicht eine individuelle Spielplatzplanung. Design, Größe und Funktionsumfang können immer an Kundenwünsche, Budget und sonstige Vorgaben angepasst werden. Die robusten Standpfosten sind in drei Varianten erhältlich und bieten viel Spielraum für eine individuelle Spielplatzgestaltung.

KIT+ CONSTRUCTION KIT WITH A LOT OF MODULES

Everything fits together and can be combined with each other in the modular KIT+ system. Design, size and range of features can be configured according to the customer's needs, budget and other specifications. The solid posts are available in three versions and offer a great flexibility to design an individual playground.



**DREI PFOSTEN, DIE NIE ROSTEN!
THREE POLES THAT NEVER RUST!**





1. LÄRCHENHOLZ unbehandelt / LARCHWOOD untreated
2. EDELSTAHL mattglanz / STAINLESS STEEL shine
3. EDELSTAHL color / STAINLESS STEEL color

RAL5015 RAL1016 RAL6017 RAL2005 RAL3002 RAL9017

Sonderfarben auf Anfrage / special colors on request

Die beliebten Spielplatzgerätelinien **ETOLIS®**, **HARENA** und **FRISIA** sind wahlweise mit Standpfosten aus unbehandeltem Lärchenholz, glasperlgestrahltem Edelstahl oder pulverbeschichteten Edelstahl erhältlich und können mit allen Modulen des **KIT+ Systems** erweitert werden.

The most popular playground equipment series **ETOLIS®**, **HARENA**, and **FRISIA** are optionally available with posts made of wood, stainless steel or powder-coated stainless steel and can be extended with the other modules of the **KIT+ system**.

BÖDEN FLOORS



DÄCHER ROOFS



SPIELTISCHE PLAY TABLES



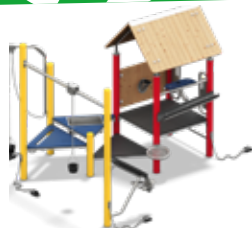

Dank der modularen Konzeption des **KIT+ Systems** sind individuelle Gestaltungen altersgerechter und sicherer Spielanlagen in verschiedenen Größen und Stilen möglich. Zur Gestaltung von Spielstrukturen mit dem **KIT+ System** stehen diverse Brüstungen, Fassaden und Dächer zur Auswahl. Auch Aufstiegs-elemente, Rampen, Leitern oder verbindende Brücken können individuell eingeplant werden.



Thanks to the modular structure of the **KIT+ system**, individual designs of age-appropriate and safe play structures in various sizes and designs are possible. Various parapets, facades and roofs are available for the design of play equipment with the **KIT+ system**. Climbing elements, ramps, ladders or connecting bridges can also be individually planned.



BRÜSTUNGEN / WÄNDE RAILINGS / WALLS

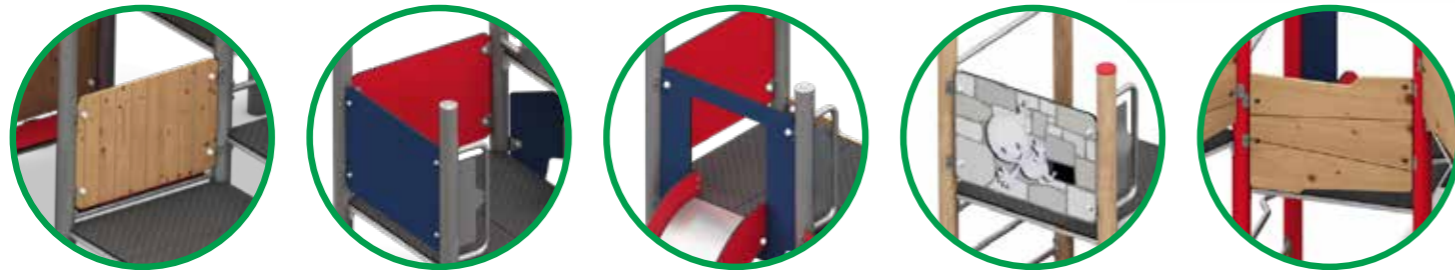

BRÜSTUNGEN / WÄNDE RAILINGS / WALLS



RAMPEN / LEITERN / AUFSTIEGE RAMPS / LADDERS / BRIDGES



BRÜCKEN BRIDGES

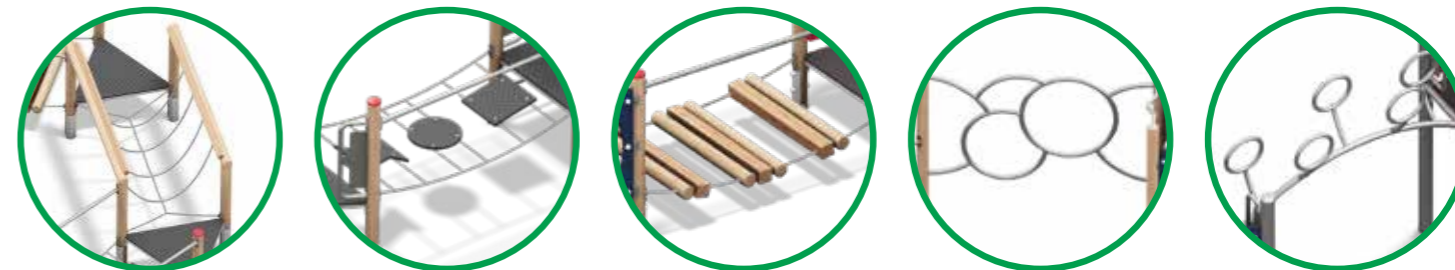

BALKONE / TUNNEL / KARUSELLE BALCONIES / TUNNELS / CAROUSELS



RUTSCHEN SLIDES



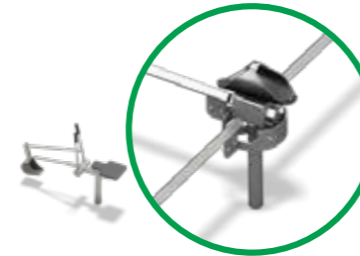



HARENA SANDSPIELGERÄTE FÜR KINDER VON 1 BIS 6 JAHREN

Experimentelles Spielen mit Wasser und Sand gehört zu den liebsten Beschäftigungen von kleinen Kindern. Schaufeln, Bauen, Transportieren, Matschen und all das mit den eigenen Händen. Als Baumeister, Kranführer oder Goldgräber sind Kinder von 1 bis 6 Jahren gerne und lange sowohl körperlich als auch kreativ aktiv. Selbstvergessen eine eigene Welt erschaffen und darin verschiedene Rollen spielen - ein paradiesischer Zustand für Kinder.

Experimental play with water and sand is one of the favorite pastimes of young children. Shoveling, building, transporting, splashing and all that with their own hands. As master builders, crane operators or gold diggers, children from 1 to 6 years of age enjoy being physically as well as creatively active for a long time. Forgetting about themselves, creating their own world and playing different roles in it is a paradisiacal state for children.



HARENA 30

09.05.130

⊕ 11,08 x 7,82 x 4,10 m

⊕ 13,95 x 11,63 m

Ⓜ 4,10 m Ⓜ 1,50 m

😊 1+



HARENA SANDPLAY EQUIPMENT FOR CHILDREN FROM 1 TO 6 YEARS



HARENA 2

09.05.102

⊕ 2,50 x 1,60 x 2,30 m ⊕ 5,03 x 4,61m

Ⓜ 2,30 m Ⓜ 0,60 m 😊 1+



33



HARENA SANDSPIELGERÄTE

FÜR KINDER VON 1 BIS 6 JAHREN

HARENA SANDPLAY EQUIPMENT

FOR CHILDREN FROM 1 TO 6 YEARS



HARENA 10
09.05.110
⊕ 1,97 x 1,95 m ⊕ 4,88 x 4,85 m
Ⓜ 1,61 m Ⓜ 0,60 m 😊 1+



HARENA 13
09.05.113
⊕ 3,36 x 2,26 x 1,79 m ⊕ 6,25 x 5,14 m
Ⓜ 1,79 m Ⓜ 0,35 m 😊 1+



HARENA 23
09.05.123
⊕ 2,93 x 2,86 x 2,30 m ⊕ 5,85 x 5,75 m
Ⓜ 2,30 m Ⓜ 0,65 m 😊 1+



HARENA 27
09.05.127
⊕ 7,84 x 6,37 x 2,30 m ⊕ 11,58 x 9,36 m
Ⓜ 2,30 m Ⓜ 0,65 m 😊 1+



HARENA 19
09.05.119
⊕ 9,45 x 6,94 x 2,83 m ⊕ 12,33 x 9,41 m
Ⓜ 2,83 m Ⓜ 0,72 m 😊 1+



HARENA 11
09.05.111
⊕ 2,53 x 1,36 x 1,72 m ⊕ 5,44 x 4,92 m
Ⓜ 1,72 m Ⓜ 0,70 m 😊 1+



HARENA 26
09.05.126
⊕ 8,48 x 5,84 x 2,30 m ⊕ 11,44 x 9,53 m
Ⓜ 2,30 m Ⓜ 0,65 m 😊 1+



HARENA 28
09.05.128
⊕ 5,28 x 3,96 x 4,10 m ⊕ 8,24 x 7,22 m
Ⓜ 4,10 m Ⓜ 1,50 m 😊 1+





HARENA 22

09.05.122

⊕ 2,90x1,95x2,30m ⊕ 5,93x4,98 m

Ⓜ 2,30 m Ⓜ 0,65 m 😊 1+

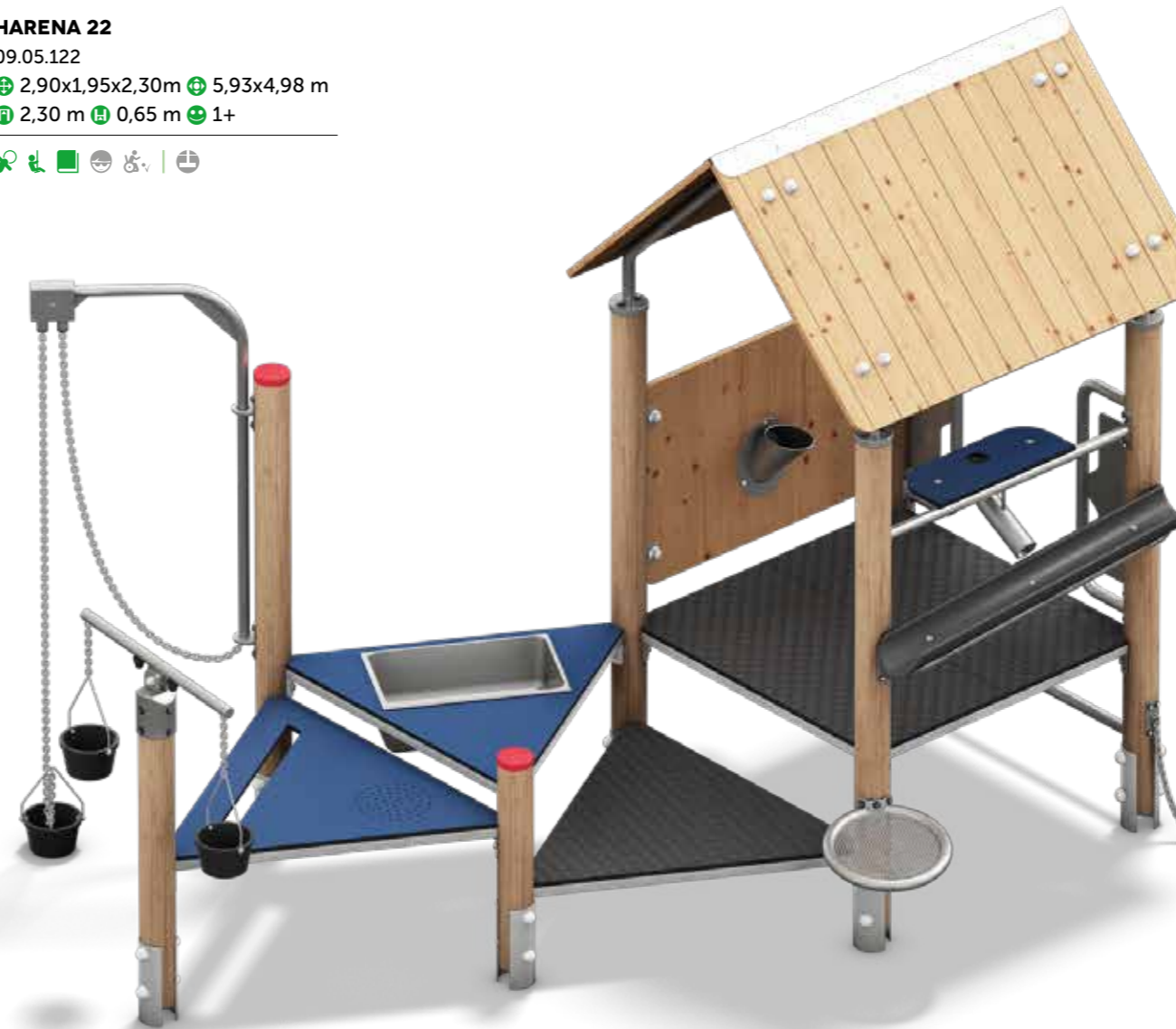

HARENA 15

09.05.115

⊕ 5,84 x 2,32 x 1,79 m

⊕ 8,78 x 5,03 m

Ⓜ 1,79 m Ⓜ 0,70 m

😊 1+



HARENA 4

09.05.104

⊕ 2,90 x 4,47 x 2,30 m ⊕ 5,80 x 7,37 m

Ⓜ 2,30 m Ⓜ 0,60 m 😊 1+





ETOLIS® 12

09.25.112

⊕ 9,11 x 6,70 x 4,10 m ⊕ 9,80 x 12,30 m

⊕ 4,10 m ⊕ 2,10 m ⊕ 3+



ETOLIS® ist das modulare Spielgerätesystem, das mit seinen modernen Komponenten Kindern zwischen 4 und 12 Jahren über Jahre hinweg Spielfreude bietet.

ETOLIS® verbindet herausfordernde und innovative Spielideen mit hochwertigen Materialien (Edelstahl, Outdoor HPL und Duoholz-Lärche) und hoher Flexibilität. Das zeitlose Design regt zu Bewegung, Kreativität und spannenden Abenteuern an.

ETOLIS® pur!

ETOLIS® is the modular play equipment system with its modern components that offers children between 4 and 10 years of playing pleasure for years to come.

ETOLIS® combines challenging and innovative play ideas with high-quality materials (stainless steel, outdoor HPL and duo wood larch) and high flexibility. The timeless design inspires movement, creativity and exiting adventures.

ETOLIS® pure!



ETOLIS® 30

09.25.130

⊕ 8,70 x 10,30 x 5,50 m

⊕ 11,50 x 13,70 m ⊕ 2,10 m

😊 3+





ETOLIS® 1
09.25.101
⊕ 3,40 x 1,94 x 2,45 m ⊕ 6,90 x 4,93 m
Ⓜ 2,45 m Ⓜ 1,50 m 😊 3+



ETOLIS® 2
09.25.102
⊕ 4,78 x 4,92 x 2,45 m ⊕ 4,66 x 4,92 m
Ⓜ 2,45 m Ⓜ 1,50 m 😊 3+

ETOLIS® 25
09.25.125
⊕ 2,70 x 2,30 x 4,10 m
⊕ 5,10 x 5,8 m
Ⓜ 0,60 m 😊 3+

🔧 🌳 📄 🌱 🧑 🏠



ETOLIS® 23
09.25.123
⊕ 6,10 x 4,80 m
⊕ 9,10 x 7,80 m
Ⓜ 1,50 m 😊 3+



ETOLIS® 6
09.25.106
⊕ 1,90 x 4,20 x 3,80 m ⊕ 7,75 x 4,90 m
Ⓜ 3,80 m Ⓜ 1,50 m 😊 3+

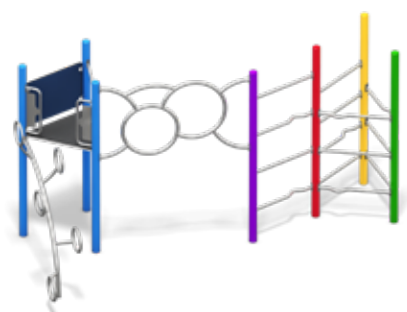

ETOLIS® 10
09.25.110
⊕ 4,85 x 2,55 x 2,50 m ⊕ 7,93 x 5,75 m
Ⓜ 2,50 m Ⓜ 1,50 m 😊 3+



ETOLIS® 9
09.25.109
⊕ 5,99 x 4,85 x 4,10 m ⊕ 9,48 x 8,14 m
Ⓜ 4,10 m Ⓜ 2,10 m 😊 3+



ETOLIS® 22
09.25.122
⊕ 6,17 x 5,15 x 3,10 m ⊕ 8,87 x 8,09 m
Ⓜ 3,10 m Ⓜ 1,50 m 😊 3+

🔧 🌳 📄 🌱 🧑 🏠



ETOLIS® 14
09.25.114
⊕ 4,48 x 1,89 x 3,10 m ⊕ 7,91 x 4,91 m
Ⓜ 3,1 m Ⓜ 1,5 m 😊 3+



ETOLIS® 11
09.25.111
⊕ 5,50 x 4,0 x 1,50 m ⊕ 8,40 x 7,00 m
Ⓜ 2,50 m Ⓜ 1,50 m 😊 3+



ETOLIS® 5
09.25.105
⊕ 5,00 x 5,28 x 3,80 m ⊕ 7,52 x 8,20 m
Ⓜ 3,80 m Ⓜ 1,50 m 😊 3+



ETOLIS® 4
09.25.104
⊕ 7,25 x 5,75 x 4,10 m
⊕ 10,20 x 8,25m
Ⓜ 4,10 m Ⓜ 1,80 m 😊 3+



ETOLIS® 15
09.25.115
⊕ 3,40 x 3,00 x 2,51 m ⊕ 6,90 x 6,00m
Ⓜ 1,50m 😊 3+

DREI PFOSTEN, DIE NIE ROSTEN! THREE POLES THAT NEVER RUST!



1. LÄRCHENHOLZ unbehandelt / LARCHWOOD untreated
2. EDELSTAHL mattglanz / STAINLESS STEEL shine
3. EDELSTAHL color / STAINLESS STEEL color

RAL5015 RAL1016 RAL6017 RAL2005 RAL3002 RAL9017



FRISIA ist ein modulares Balanciersystem. Lärchenholz, HPL und Edelstahlkomponenten werden hier für Kinder zwischen 4 bis 10 Jahren zusammengefügt.

FRISIA is a modular balancing system, which combines larch-wood, HPL and stainless steel for kids between 4 and 10 years.

FRISIA KOMBINATION A

09.05.210

⊕ 4,97 x 2,84 m ⊕ 7,99 x 5,85 m

Ⓜ 1,19 m Ⓜ 0,41 m 😊 3+

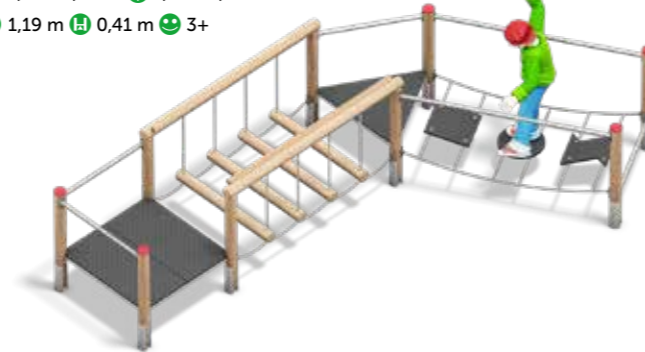

FRISIA besteht aus Elementen des KIT+Systems und ist flexibel einsetzbar. Erstellen Sie ihren eigenen Balancierparcours, gerne auch in Kombination mit Sandspielementen und Multispielmöbeln des KIT+ Systems.

FRISIA consists of elements of the KIT+ system and can be used flexibly. Create your own balancing course, even in combination with sand play elements and multi play modules of the KIT+ system.

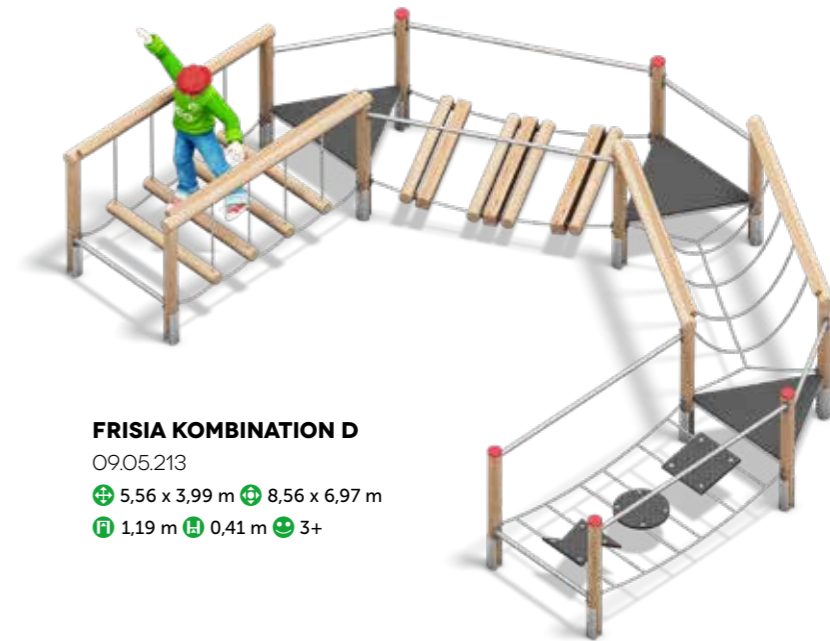

FRISIA KOMBINATION D

09.05.213

⊕ 5,56 x 3,99 m ⊕ 8,56 x 6,97 m

Ⓜ 1,19 m Ⓜ 0,41 m 😊 3+

FRISIA KOMBINATION B

09.05.211

⊕ 6,97 x 5,07 m

⊕ 9,97 x 8,09 m

Ⓜ 1,19 m Ⓜ 0,41 m 😊 3+



FRISIA KOMBINATION E

09.05.214

⊕ 5,87 x 5,57 m ⊕ 8,84 x 8,57 m

Ⓜ 1,19 m Ⓜ 0,41 m 😊 3+

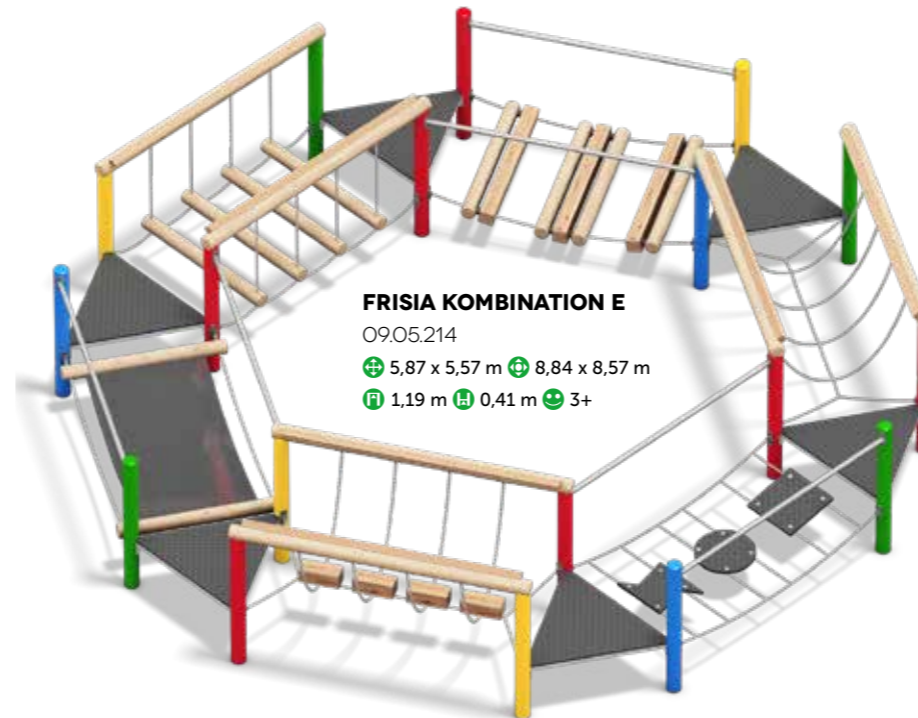

FRISIA KOMBINATION C

09.05.212

⊕ 5,11 x 5,10 m ⊕ 8,11 x 8,10 m

Ⓜ 1,19 m Ⓜ 0,41 m 😊 3+



DREI PFOSTEN, DIE NIE ROSTEN! THREE POLES THAT NEVER RUST!

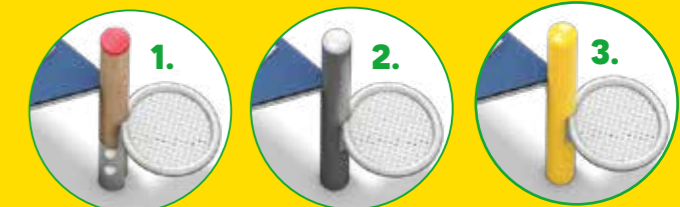

1. LÄRCHENHOLZ unbehandelt / LARCHWOOD untreated
2. EDELSTAHL mattglaz / STAINLESS STEEL shine
3. EDELSTAHL color / STAINLESS STEEL color

RAL5015 RAL1016 RAL6017 RAL2005 RAL3002 RAL9017



BALANCIEREN + BEWEGEN

FÜR KINDER VON 3 BIS 99 JAHREN

BALANCING + MOVING

FOR KIDS FROM 3 TO 99 YEARS



Anlage „Wittmund“ ist ein klassisches Spielplatzgerät, das Bewegung und Koordinationsfähigkeiten fördert. Um das Gerät an Bedürfnisse von Menschen mit Einschränkungen anzupassen, haben wir es optimiert. Jedes Einzelelement hat andersfarbige Handlaufelemente um sie einfach voneinander unterscheiden zu können. Unterschiedliche Schwierigkeiten stellen eine steigende Herausforderung dar. Werden die Herausforderungen als zu schwer empfunden, kann die Anlage an jedem Einzelelement sicher und einfach verlassen werden.

„Wittmund“ is a classic playground equipment which promotes movement and coordination skills. To adapt this item to needs of people with developmental disabilities, we have optimized it. Each single element has guard rails in a different colour to make them easy to distinguish from each other. Different difficulties are a growing challenge. If the challenges are perceived as too difficult, the equipment can be safely and easily left at each individual element.

WITTMUND

12.05.300

⊕ 12,95 x 2,08 m ⊕ 15,95 x 5,05 m

Ⓜ 1,25 m Ⓜ 0,50 m 😊 3+



LEERHAVE

12.05.305

⊕ 7,90 x 1,27 m ⊕ 10,90 x 4,27 m

Ⓜ 1,25 m Ⓜ 0,50 m 😊 3+



PAK frei



BALANCIEREN + BEWEGEN

FÜR KINDER VON 3 BIS 99 JAHREN

BALANCING + MOVING

FOR KIDS FROM 3 TO 99 YEARS



MOKADI

06.02.080

⊕ 8,11 x 4,38 m ⊕ 11,17 x 7,41 m

Ⓜ 0,99 m Ⓜ 0,99 m 😊 3+



MOKADI ULTRA

06.02.080.004

⊕ 12,55 x 8,55 m ⊕ 15,55 x 11,55 m

Ⓜ 1,56 m Ⓜ 1,30 m 😊 4+



GECKO

06.01.021

⊕ 4,65 x 0,10 x 0,40 (Variabel)

⊕ 7,65 x 3,65 (Variabel)

Ⓜ 0,40 m

Ⓜ 0,99 m 😊 3+



BALANCIERANLAGE SCHULHOF

BALANCING PARCOUR SCHOOL YARD

06.02.055

⊕ 11,32 x 4,91 m ⊕ 14,32 x 7,92 m

Ⓜ 0,40 m Ⓜ 0,40 m 😊 3+

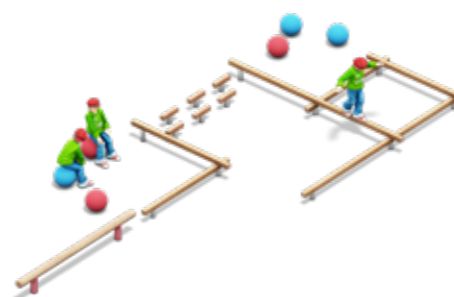

Die Balancier- und Sitzanlage ist ein ganz besonderes Gestaltungselement für den Schulhof oder anderen Plätze an denen sich Kinder und Jugendliche aufhalten. Balancieren, Chillen oder beides.... Die Sitzkugeln sind im Lieferumfang enthalten und bestehen aus einem farbigen Gummigemisch.

The balancing and seating equipment is a very special design element for the schoolyard or other places where children and young people spend time. Balancing, chilling or both.... The seating balls are included and are made of a colored rubber mixture.

GUMMI-WACKELBAND MIT GEWEBEEINLAGE

RUBBER WOBBLE TRACK WITH FABRIC INSERT

06.04.103

⊕ 7,00 x 1,22 m ⊕ 10,00 x 4,22 m

Ⓜ 2,19 m Ⓜ 0,60 m 😊 6+

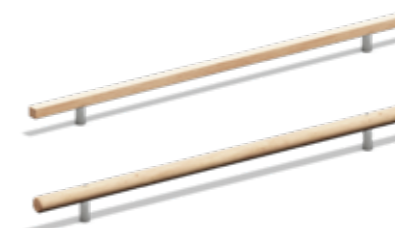
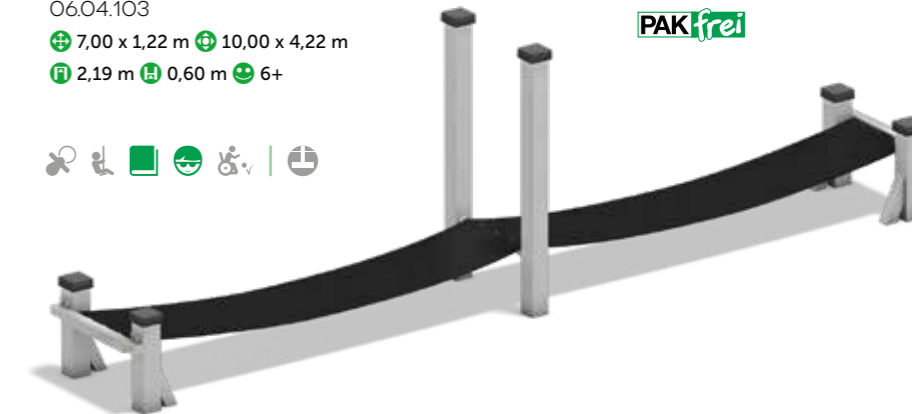

BALANCIERBALKEN

BALANCE BEAM

06.01.020

Kantholz squared timber

9 x 9 cm

⊕ 4,00 x 0,10 m ⊕ 7,00 x 3,09 m

Ⓜ 0,29 m Ⓜ 0,29 m 😊 3+

06.01.030 Rundholz Roundwood

ø 14 cm

⊕ 4,00 x 0,14 m ⊕ 7,00 x 3,14 m Ⓜ 0,40 m

Ⓜ 0,40 m 😊 3+





Der spannende Safari-Parc ist eine super Idee für jeden Spielplatz und Schulhof. Viele Einzelgeräte haben eine Fallhöhe von unter 60 cm. Dies macht es möglich, die Geräte auf einer versiegelten Fläche zu errichten. Alle Geräte unseres beliebten Safari-Parcs sind mit Pfostenschuhen ausgestattet, um eine möglichst hohe Lebensdauer zu erreichen. Die Hölzer sind gehobelt, kerngetrennt und kesseldruckimprägniert. Alle beweglichen Teile sind an feuerverzinkten Ketten befestigt. Stellen Sie sich Ihren eigenen Safari-Parcours zusammen. Sie können alle Geräte beliebig kombinieren.

The exciting Safari Parc is a great idea for every playground and schoolyard. Many of the single items have a free fall height of less than 60 cm. This allows installing the devices on a sealed surface. All units of our popular Safari Parcs are equipped with post shoes, which ensures a long life expectancy. The wood is planed, core-separated and pressure treated. All moving parts are attached to hot-dip zinc chains. Put together your own Safari Parc course. You can combine all items any way you like.



PARCOURS, 5-TEILIG (BEISPIEL)
COURSE 5-PCS. (EXAMPLE)
12.05.151

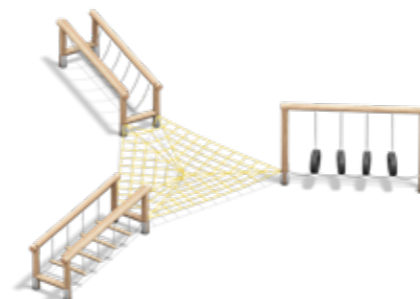

PARCOURS, 4-TEILIG „NETZ“ (BEISPIEL)
COURSE, 4-PCS. „NET“ (EXAMPLE)
12.05.155



STELZENLAUF, 6-TEILIG
GIANT'S CAUSEWAY, 6-PCS.
12.05.090
⊕ 1,51 x 0,90 m ⊕ 4,50 x 3,90 m
Ⓜ 1,90 m Ⓜ 0,50 m 😊 4 +

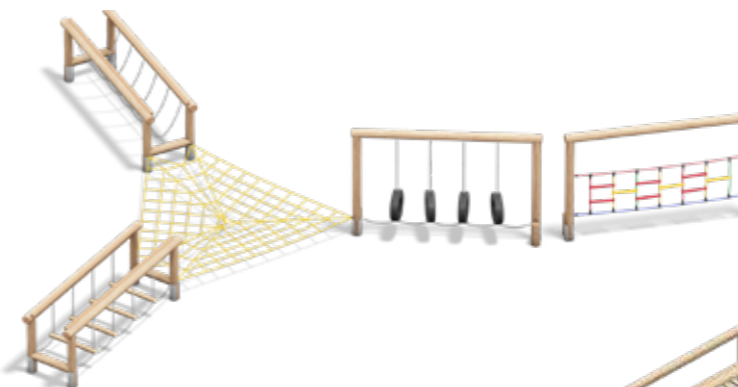

PARCOURS, 5-TEILIG „NETZ“ (BEISPIEL)
COURSE, 5-PCS. „NET“ (EXAMPLE)
12.05.150



PARCOURS, 7-TEILIG (BEISPIEL)
7-PCS. COURSE (EXAMPLE)
12.05.152



PARCOURS, 17-TEILIG (BEISPIEL)
COURSE 17-PCS. (EXAMPLE)
12.05.217



KRIECHRÖHRE
CRAWLER TUNNEL
12.05.110
⊕ 2,60 x 1,05 m ⊕ 5,60 x 4,04 m
Ⓜ 1,10 m Ⓜ 0,16 m 😊 4 <> 10

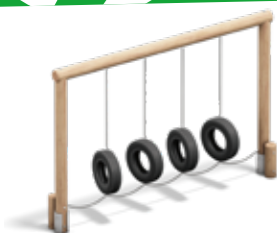

AFFENSCHAUKEL
TYRE CHALLENGE
12.05.035



SCHWINGSTUFEN
SWING CHALLENGE
12.05.040



SPAGATBRÜCKE
TIGHTROPE CHALLENGE
12.05.025



POLYESTERHÄNGEMATTE
POLYESTER HAMMOCK
12.05.135

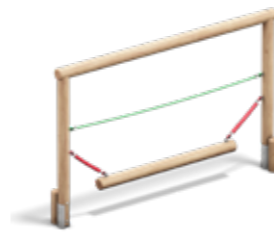

WACKELBALKEN
WOBBLE BEAM
12.05.134

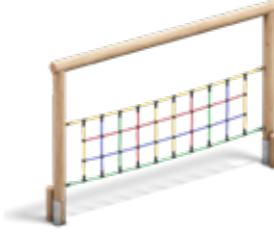

KLETTERNETZ
CLIMBING NET
12.05.132

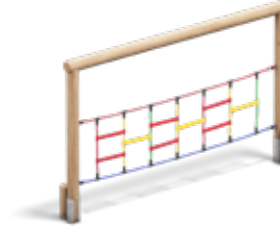

KLETTERSPROSSEN
CLIMBING RUNGS
12.05.137

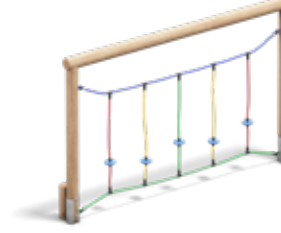

KLEINE KLETTERTELLER
SMALL DISKS
12.05.145

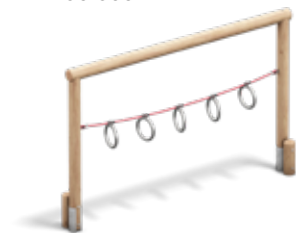

HALTERINGE
HOLDING RINGS
12.05.136

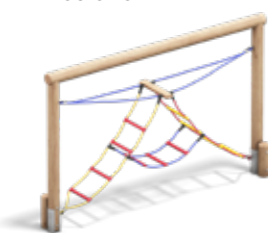

KLETTERSPIEL-3ER-LEITER
3-PART-LADDER
12.05.143



SPROSSENLEITER-BRÜCKE
ROPE LADDER CHALLENGE
12.05.065



HANGELSEIL-STRECKE
HANGING ROPE COURSE
12.05.075



WACKELBRÜCKE
BEAM BRIDGE
12.05.045



DSCHUNGELBRÜCKE
COCONUT BRIDGE
12.05.050



INDIANA-JONES-BRÜCKE
INDIANA JONES BRIDGE
12.05.055



KETTEN-SCHLAUFEN-BRÜCKE
CAT'S CRADLER BRIDGE
12.05.070

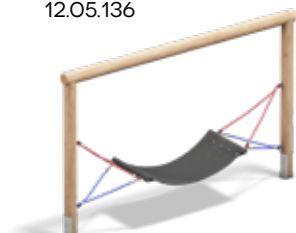

GUMMIHÄNGEMATTE
RUBBER HAMMOCK
12.05.133

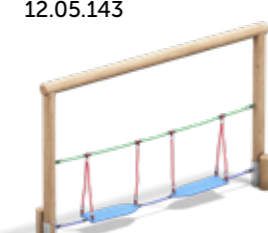

SURFER
SURFER
12.05.141

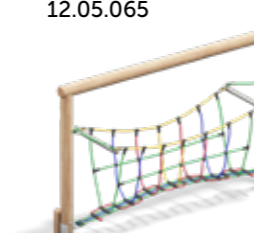

BOGENBRÜCKE
ARCH BRIDGE
12.05.144

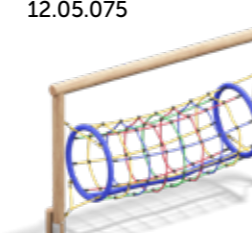

ABENTEUERTUNNEL
ADVENTURE TUNNEL
12.05.142



QUATERMAIN-BRÜCKE
STEPPING STONE BRIDGE
12.05.060

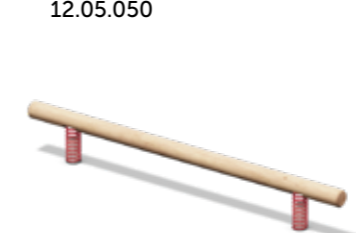

FEDERBALANCIERBALKEN
SPRING BALANCE BEAM
12.05.010

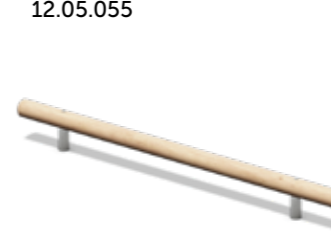

BALANCIERBALKEN
BALANCE BEAM ROUND
12.05.020



DREHBALKEN
ROLLING BALANCE BEAM
12.05.015



ZWISCHENTRITT
TRANSIT STEP
12.05.030
Mit gummiertem Fußtritt
With rubber boot



FEDERPLATTE *
SPRING DISK
12.05.085

* Nur als Verbindung zwischen zwei festen Geräten nutzbar.
* Can only be used as a connection between two fixed devices.

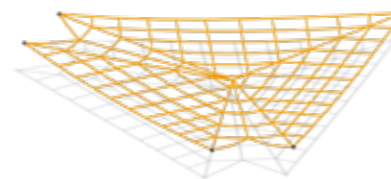

DREIECKSV ERBINDUNGSNETZ
TRIANGLE SCRAMBLE NET
12.05.100
⊕ 2,86 x 2,44 m ⊕ 5,59 x 5,26 m ⊕ 0,60 m
⊕ ca. 0,45 m (max. 0,60 m) ⊕ 4 +



FEDERBRETT-WELLE
SPRING PLANKS
12.05.105



FUNRUN-PARCOURS, 10-TEILIG

FUNRUN-COURSE, 10-PCS.

40.12.625

Diese FUN RUN-Kombination besteht aus 10 Geräten, die einen Rundparcours bilden. This FUN RUN combination consists of 10 items that form a circular course.

⊕ abhängig von Gestaltung depending on design

⊕ umlaufend 1,50 m circumferentially 1,50 m

👤 1,30 m 😊 4+

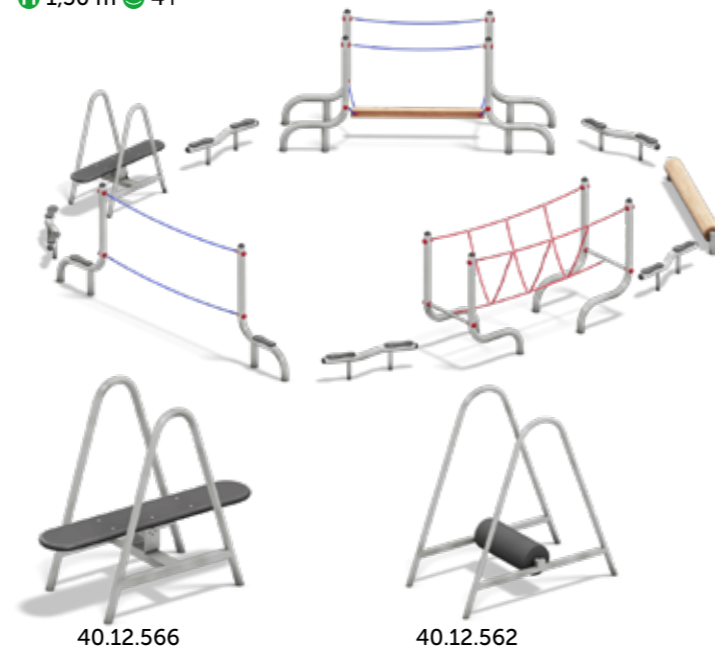

Alle FUN RUN-Module sind neben der Basis-Version aus feuerverzinktem Stahl auch zusätzlich pulverbeschichtet (RAL-Farben) erhältlich.

RAL5015 **RAL1016** **RAL6017** **RAL2005** **RAL3002** **RAL9017**

Sonderfarben auf Anfrage / special colors on request

All FUN RUN modules are optionally available with powder-coated steel (RAL colors) in addition to the basic galvanized steel version.

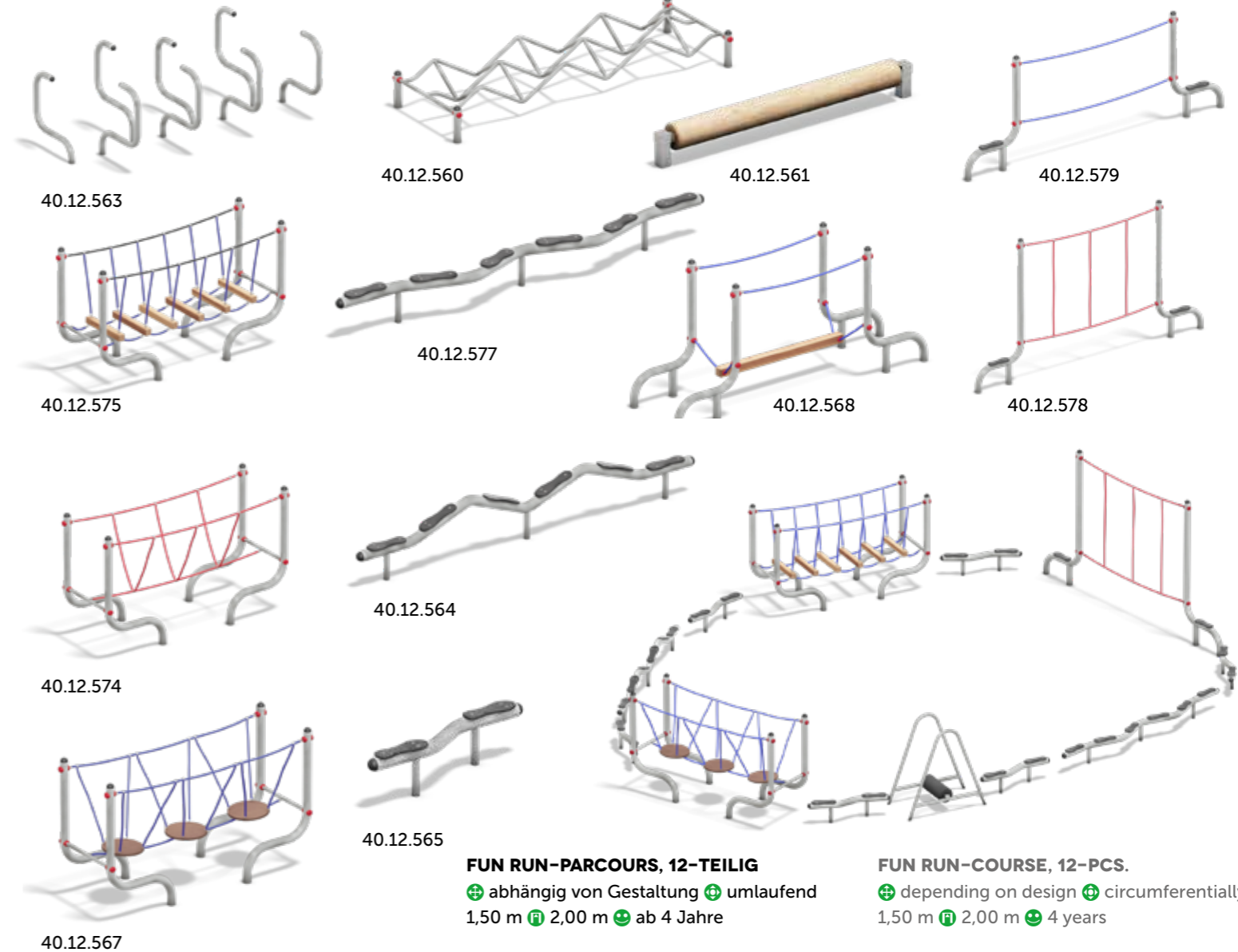

FUN RUN-PARCOURS, 12-TEILIG

⊕ abhängig von Gestaltung ⊕ umlaufend

1,50 m 👤 2,00 m 😊 ab 4 Jahre

FUN RUN-COURSE, 12-PCS.

⊕ depending on design ⊕ circumferentially

1,50 m 👤 2,00 m 😊 4 years

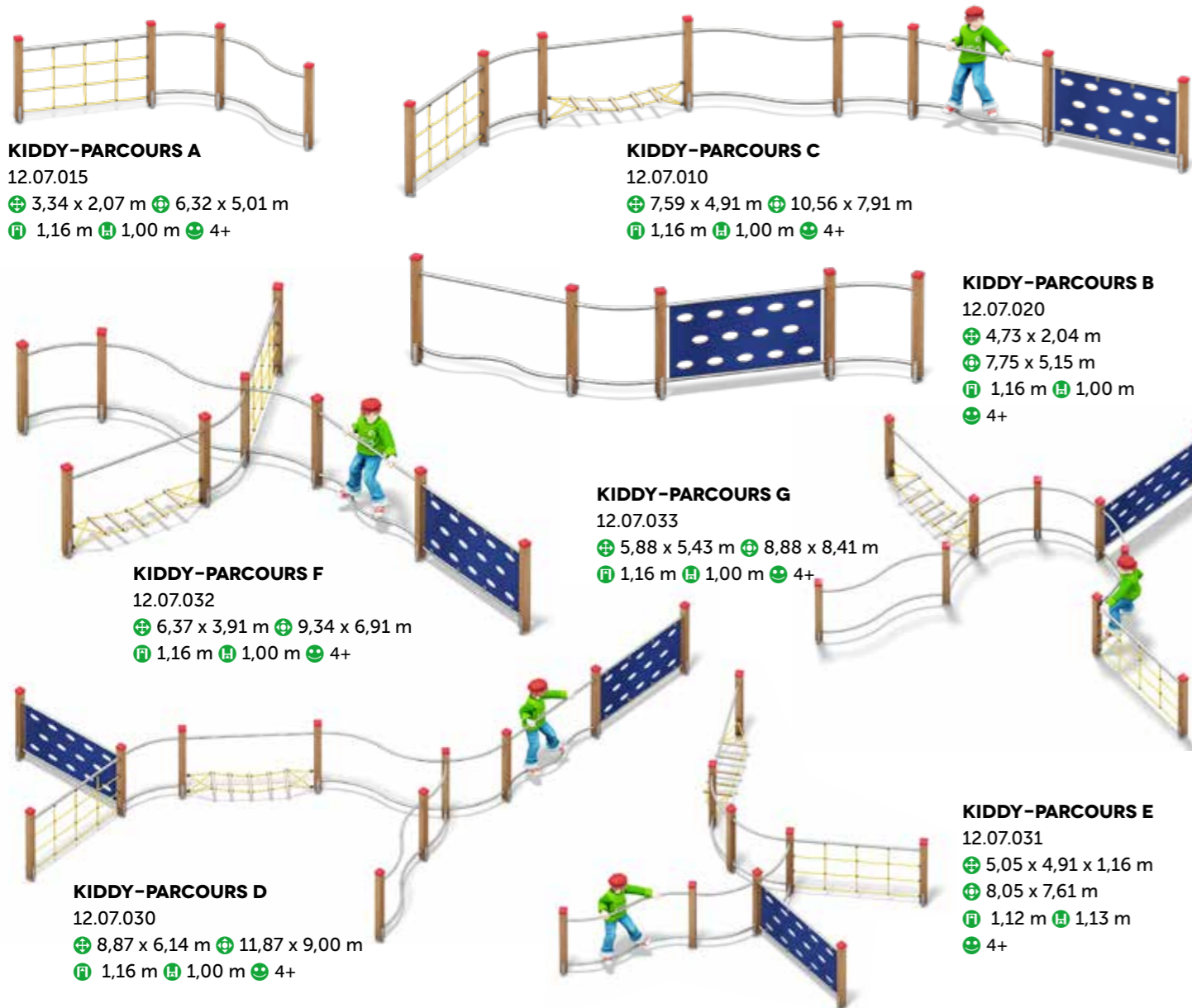

KIDDY-PARCOURS A
12.07.015
⊕ 3,34 x 2,07 m ⊕ 6,32 x 5,01 m
Ⓜ 1,16 m Ⓜ 1,00 m 😊 4+

KIDDY-PARCOURS C
12.07.010
⊕ 7,59 x 4,91 m ⊕ 10,56 x 7,91 m
Ⓜ 1,16 m Ⓜ 1,00 m 😊 4+

KIDDY-PARCOURS B
12.07.020
⊕ 4,73 x 2,04 m
⊕ 7,75 x 5,15 m
Ⓜ 1,16 m Ⓜ 1,00 m
😊 4+

KIDDY-PARCOURS G
12.07.033
⊕ 5,88 x 5,43 m ⊕ 8,88 x 8,41 m
Ⓜ 1,16 m Ⓜ 1,00 m 😊 4+

KIDDY-PARCOURS F
12.07.032
⊕ 6,37 x 3,91 m ⊕ 9,34 x 6,91 m
Ⓜ 1,16 m Ⓜ 1,00 m 😊 4+

KIDDY-PARCOURS D
12.07.030
⊕ 8,87 x 6,14 m ⊕ 11,87 x 9,00 m
Ⓜ 1,16 m Ⓜ 1,00 m 😊 4+

KIDDY-PARCOURS E
12.07.031
⊕ 5,05 x 4,91 x 1,16 m
⊕ 8,05 x 7,61 m
Ⓜ 1,12 m Ⓜ 1,13 m
😊 4+



SLACKLINE 4M
06.01.045
⊕ 4,12 x 0,24 m ⊕ 7,12 x 3,24 m
Ⓜ 0,40 m Ⓜ 0,40 m 😊 4+

SLACKLINE 6M
06.01.050 o. ABBILDUNG WITHOUT PIC.
⊕ 6,12 x 0,24 m ⊕ 9,12 x 3,24 m
Ⓜ 0,55 m Ⓜ 0,55 m 😊 ab 4 Jahre
🌀 🚫 📖 🧘 🚶 📏

BALANCIERSEIL BALANCING ROPE
06.01.040 STAHLSEIL STEEL ROPE
⊕ 4,12 x 0,24 m ⊕ 7,12 x 3,24 m Ⓜ 0,40 m
Ⓜ 0,40 m 😊 6+
🌀 🚫 📖 🧘 🚶 📏

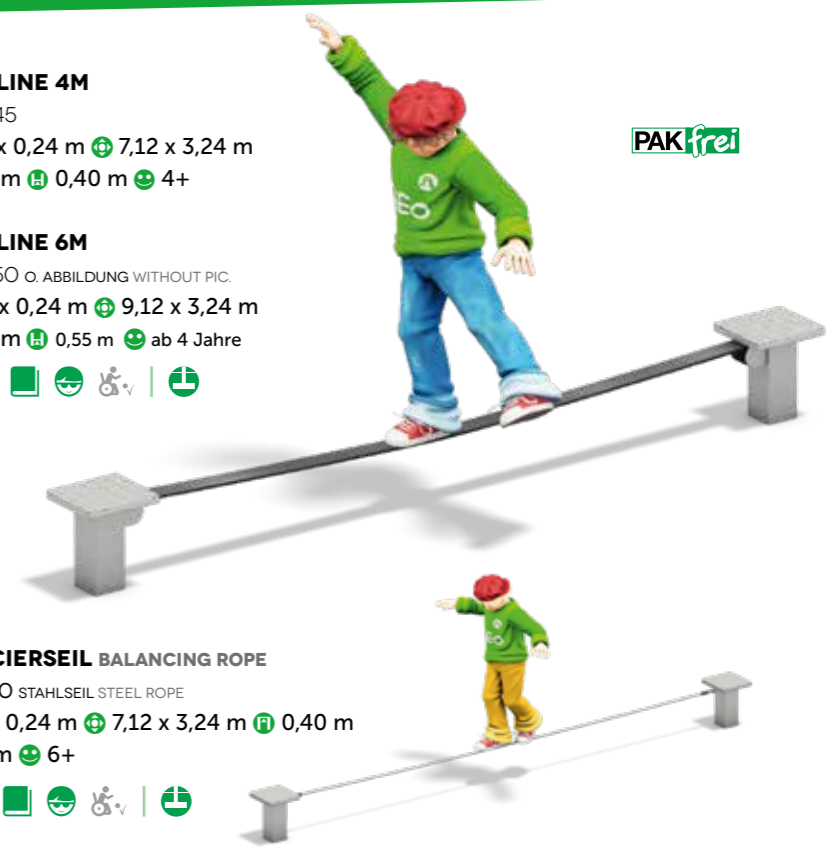

Slackline ist eine Trendsportart, die dem Seiltanzen sehr ähnlich ist, jedoch auf einem 8 cm breiten Gurtband praktiziert wird. Im Gegensatz zum Balancieren auf einem Drahtseil, das so straff gespannt ist, dass es sich kaum bewegt, dehnt sich eine Slackline unter dem Gewicht des Slackliners. Dadurch wird das Balancieren sehr dynamisch und verlangt ein ständiges aktives Ausgleichen. Die Anforderungen des Slackens an den Nutzer besteht in einer Kombination aus Balance, Koordination und Konzentration.
Das Gerät wird fix und fertig vormontiert auf einer Betonplatte (4,00 x 0,50 x 0,15 m) angeliefert.

Slackline is a popular sport, which is very similar to tightrope walking, but is practiced on an 8 cm wide webbing. In contrast to balancing on a tightrope which is stretched so tightly, that it hardly moves, a Slackline stretches under the weight of the Slackliner. This makes balancing very dynamically and requires continuous active balancing. Slacklining requires a combination of balance, coordination and concentration.
The item is supplied completely pre-assembled on a concrete slab (4.00 x 0.50 x 0.15 m).



SPIELTISCHE

DESIGNED BY MANFRED WEBEL

PLAY AND GAME TABLES

DESIGNED BY MANFRED WEBEL



MANFRED WEBEL

1965 geboren in Paderborn ...
Als Bildhauer fasziniert ihn die Frage, wie Kunst einen Beitrag für eine menschliche Gesellschaft leisten kann.
Selbst Vater dreier Söhne, engagiert sich der Künstler mit großer Freude für Kinder und Jugendliche.
„Als ich als Erstes den Spieltisch geschaffen habe, war ich überrascht, dass es wenige wirklich schöne Spielgeräte gibt, die gleichzeitig dauerhaft funktionieren und großen Spiel-Spaß ermöglichen. Seitdem baue ich mit fließenden Formen und fröhlichen Farben Objekte, die offene Gestaltungsmöglichkeiten anbieten und Kreativität und Wahrnehmung fördern.“



9 GEWINNT

Für lebendige Schulhöfe habe ich mit meinem jüngsten Sohn „9 gewinnt“ entwickelt. Hier heißt es: konzentriert zielen, ruhig werfen, schnell rechnen. Denn gewinnen kann nur, wer exakt 9 Punkte aufaddiert. Zu viele Punkte geworfen? Diese werden einfach abgezogen. Zu zweit, zu viert, in Teams - immer ein großer Spaß. Bei Älteren beliebt sind Varianten, bei denen multipliziert und dividiert wird.

9 WINS

For vital schoolyards I developed „9 wins“ together with my youngest son. Most important here: concentrated aiming, calm throwing, quick calculation. Because only the one who adds up to exactly 9 points can win. Thrown too many points? These are simply deducted. Playing with two & four people or in teams - it's always great fun. Older children like variations that involve multiplying and dividing.



1965 born in Paderborn ...
As a sculptor, he is fascinated by the question of how art can make a contribution to human society. Being a father of three sons himself, the artist is committed to children and young people with great joy. He has made a name for himself nationwide as a designer of play objects in a short time. This comes as no surprise, as he keeps involving future users in the development process.
„When I first created the table, I was surprised to find that there are only a few really nice gaming devices that work and have a lot of fun at the same time. Since then, I have been building objects with flowing forms and cheerful colours that offer open design possibilities and promote creativity and perception.“

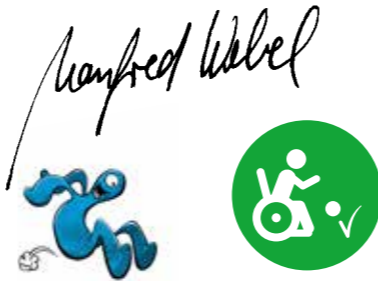

WEBEL SPIELTISCH 9-GEWINNT

WEBEL PLAYTABLE „9 WINS“

40.20.061

⊕ 2,10 x 1,00 x 0,75 m

⊕ 5,15 x 4,00 m ⊕ 0,75

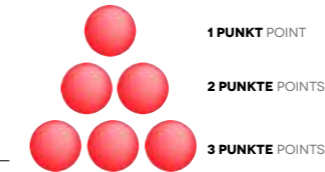

WEBEL SPIELTISCH OUTDOOR

WEBEL PLAYTABLE OUTDOOR

40.20.030

für Wasser und Sand, fest montiert

for sand and water, permanently mounted

⊕ 2,78 x 1,70 x 0,90 m ⊕ 5,78 x 4,70 m ⊕ 0,90 m



WEBEL SPIELTISCH SPLASH

WEBEL PLAYTABLE SPLASH

40.20.045

beweglich, aufgeschraubt oder fest montiert

movable, screwed or mounted

⊕ 1,22 x 0,82 x 0,55 m ⊕ 4,22 x 3,82 m ⊕ 0,55



SPLASH, das ist die kleine Pfütze für kreatives Matschen. Mit einem Eimer Wasser wird **SPLASH** zum See, auf dem Kinder Boote fahren lassen. Mit einer Schippe Sand legen sie Dämme an und formen ein Flussdelta, das sie im nächsten Moment überschwemmen.

SPLASH, that's the little puddle for the creative way of messing around. With a bucket of water, **SPLASH** becomes a lake where kids run boats. With a pile of sand they build dams and form a river delta, which they flood the next moment.



SINNESSPIEL

MIT DEN AUGEN, OHREN UND DER NASE SPIELEN

SENSUAL PLAY

PLAYING WITH THE EYES, EARS AND NOSE



SCHNULLI XYLOPHON
SCHNULLI XYLOPHONE
30.04.234
⊕ 0,8 x 0,65 x 0,60 m 😊 3+

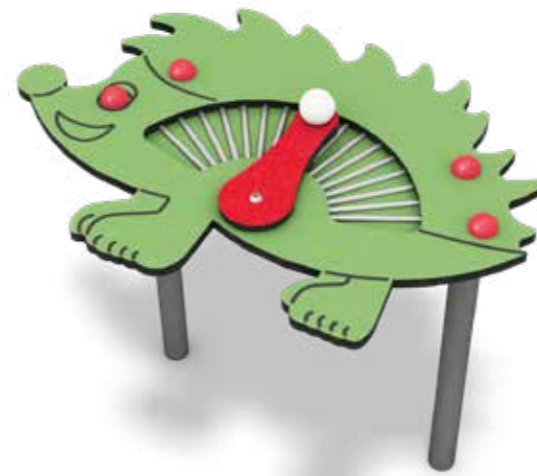

SCHNULLI WASHBRETT
SCHNULLI WASHBOARD
30.04.236
⊕ 0,78 x 0,54 x 0,60 😊 3+



SCHNULLI DRUMS
SCHNULLI DRUMS
30.04.232
⊕ 0,77 x 0,64 x 0,60 m 😊 3+



FLÜSTERBLUME
WHISPERING FLOWER
09.24.670
⊕ 1,00/1,20 m 😊 3+



EFFEKT-DREHSCHIEBEN
EFFECT TURN TABLES
⊕ 1,00 x 0,31 x 0,60 m 😊 3+

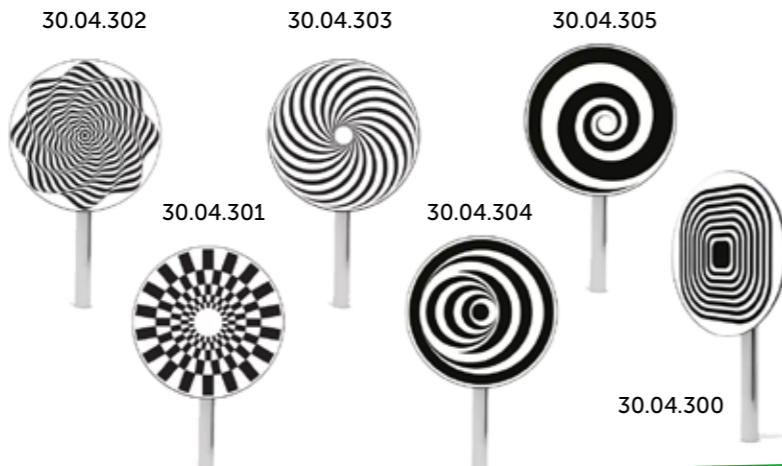

KRÄUTERTORTE HERBS TART
30.04.270
⊕ 1,30 x 1,30 x 0,90 m 😊 3+

Die Kräutertorte dient als Pflanzbeet für Pflanzen, die Kindern Geschmack und Geruch von Kräutern und Natur nahebringen.

The herbs tart is used as a planting pot for plants that introduce children to the taste and smell of herbs and nature.



SCHNÜFFELTREPPE
SNIFF STAIRS
30.04.271
⊕ 1,50 x 1,30 x 0,90 m 😊 3+





WASSERSPIELE

WASSER UND SAND - ELEMETARES ERLEBEN

WATER FEATURES

WATER AND SAND



RHEIN

11.14.330
 ⊕ 5,59 x 4,49 m ⊕ 8,65 x 7,54 m
 ⓘ 1,24 m 😊 3+

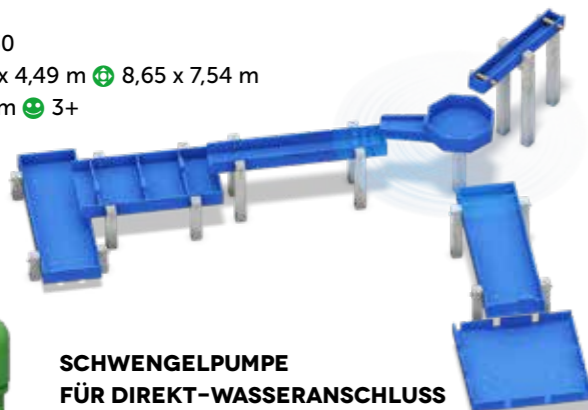

DONAU

11.14.340
 ⊕ 4,92 x 0,96 m
 ⊕ 7,92 x 3,96 m
 ⓘ 1,10 m 😊 3+

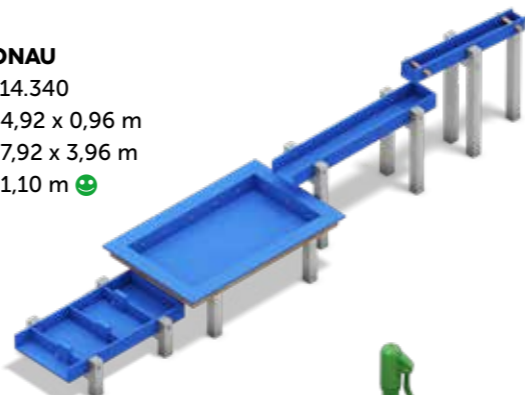

SCHWENGELPUMPE FÜR DIREKT-WASSERANSCHLUSS

HANDLE PUMP FOR DIRECT WATER CONNECTION
 16.08.473
 ⊕ 1,45 x 0,60 m



ELBE

11.14.310
 ⊕ 7,25 x 3,45 m ⊕ 8,75 x 6,45 m ⓘ 1,00 m 😊 3+

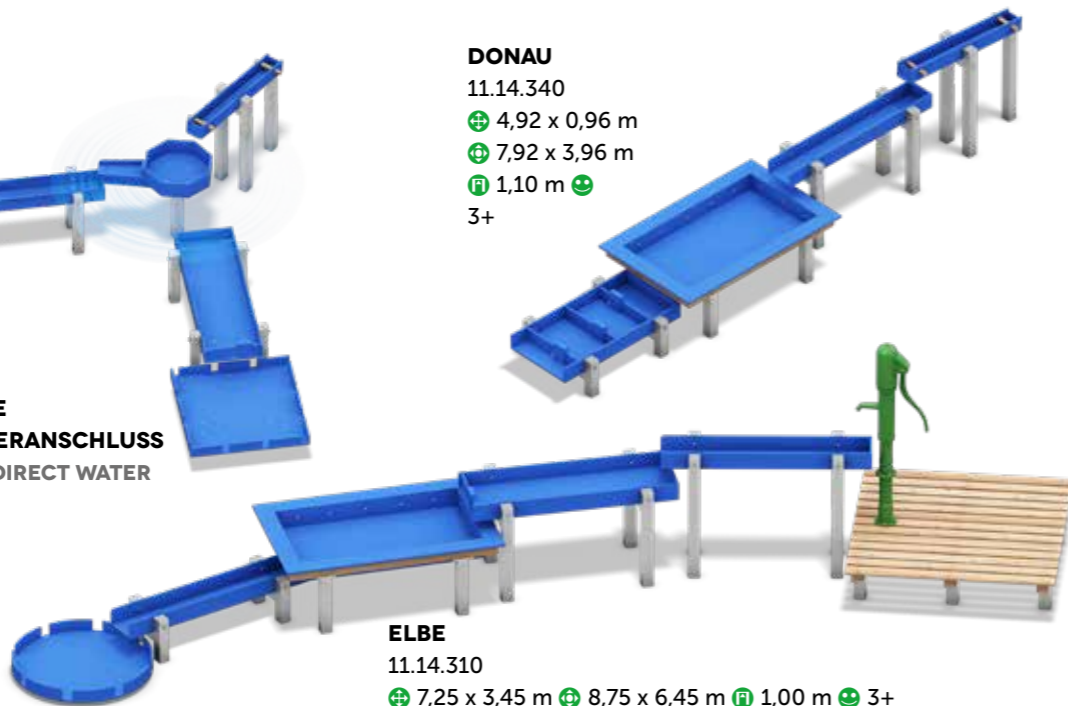

BECKEN MIT KLAPPE
 BASIN WITH FLAP
 11.14.280
 ⊕ 1,50 x 0,67 m



MATSCHTISCH, RUND
 MUD TABLE ROUND
 11.14.284
 ⊕ Ø 1,00 m



HEBERINNE
 LIFTING CHUTE
 11.14.287
 ⊕ 1,20 x 0,43 m



VERTEILERBECKEN
 DISTRIBUTOR BASIN
 11.14.281
 ⊕ 1,50 x 0,67 m

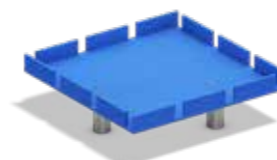

MATSCHTISCH, ECKIG
 MUD TABLE, SQUARED
 11.14.285
 ⊕ 1,00 x 1,00 m



WASSERBECKEN
 WATER BASIN
 11.14.288
 ⊕ 1,20 x 0,76 m

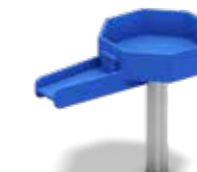

VERTEILER, DREHBAR
 FEEDING BASIN, TURNABLE
 11.14.292
 ⊕ Ø 1,37 m



VIERECKRINNE
 SQUARED CHUTE
 11.14.283
 ⊕ 1,50 x 0,41 m

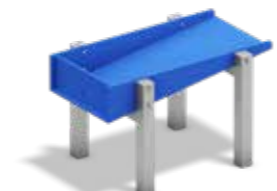

STAUBECKEN
 RETAINING RESERVOIR
 11.14.294
 ⊕ 1,20 x 0,76 m



BECKEN MIT 3 STAUSTUFEN
 BASIN WITH 3 BARRAGES
 11.14.295
 ⊕ 1,20 x 0,76 m



BOOTSBECKEN
 BOAT BASIN
 11.14.296
 ⊕ 1,60 x 1,00 m



PUMPENPODEST
 PUMP PLATFORM
 11.14.289
 ⊕ 1,50 x 1,50 m ⓘ 0,25 m

Je nach Zusammenstellung der Wasserspielanlage ergeben sich für jedes Modul unterschiedliche Einbauhöhen.
 Depending on the configuration of the water play system, there are different installation heights for each module.



KARUSSELLE

LUUPZ® - KARUSSELLE FÜR KINDER VON 1 - 5 JAHREN

CAROUSELS

LUUPZ® - FOR CHILDREN FROM 1 TO 5 YEARS



„LUUPZ® - go rounds“ sind Kinderkarusselle die maximale Lebensfreude und -energie bei minimalem Platzbedarf auf den Spielplatz bringen. Auf den kindgerecht dimensionierten Karussellen erproben, nutzen und erweitern Kinder spielerisch ihr Körperwissen - zum Beispiel durch den spaßigen Pirouetten-Effekt. Die einfachen geometrischen Körper sind modellabhängig in verschiedenen Materialien (Holz, Edelstahl, HPL oder EPDM in div. Farben) erhältlich. Durch die Vielfalt an Farben und Formen finden sich für jedes Spielplatz-Design passende LUUPZ® Karusselle um den Spielwert zu erweitern.

„LUUPZ® - go rounds“ are children’s carousels that bring maximum vitality and energy to the playground with minimal space requirements. On the child-friendly sized carousels, children playfully test, use and expand their body knowledge - for example by the funny pirouette effect. The simple geometric bodies are available in different materials (wood, stainless steel, HPL or EPDM in various colors) depending on the model. Due to the variety of colors and shapes, suitable LUUPZ® carousels can be found for every playground design to extend the play value.



LUUPZ 1
Teller-Karussell
Plate Carousel
02.06.700



LUUPZ 2
Teller-Karussell hoch
Plate Carousel highly
02.06.706



LUUPZ 3
Würfel-Karussell
Cube Carousel
02.06.771



LUUPZ 4
Kugel-Karussell
Ball Carousel
02.06.730



LUUPZ 5
Halbkreis-Karussell
Semi-Gyro Carousel
02.06.751



LUUPZ 6
Karussell Pingu
Pingu Carusel
02.06.775



LUUPZ 7
Karussell Moli
Moli Carusel
02.06.776



LUUPZ 8
Lolly-Karussell
Lolly Carusel
02.06.710



LUUPZ 9
Bogen-Karussell
Bow Carusel
02.06.713



LUUPZ 10
Kreisel-Karussell
Gyro Carusel
Art.-Nr. 02.06.773



LUUPZ 11
Kreisel-Karussell 15°
Gyro Carusel 15°
02.06.740



LUUPZ 12
Halbkreis-Karussell
Semi-Gyro Carusel 15°
02.06.745



LUUPZ 13
Lolly-Karussell 15°
Lolly Carusel 15°
02.06.720



LUUPZ 14
Bogen-Karussell 15°
Bow Carusel 15°
02.06.722



LUUPZ 15
Langbogen-Karussell 15°
Long Bow Carusel 15°
02.06.725

KIT+ ANBAUKARUSSELL



KARUSSELLE

BIG LUUPZ® FÜR KINDER VON 5 - 99 JAHREN



CAROUSELS

BIG LUUPZ® - FOR CHILDREN FROM 5 TO 99 YEARS



Das neue Karussell-Konzept Big LUUPZ® ist die konsequente technische Weiterentwicklung der beliebten und bewährten PLAYPARC-Karusselle für den klassischen aber auch den bodengleichen Einbau. Mit dem einmaligen Big LUUPZ®-Wannensystem (BLWS), das gleichzeitig als Fundament dient, ist der bodengleiche Einbau aller Karusselle ein Kinderspiel. Bei den Modellen TIVOLI oder BREAKDANCER ist der mittlere Pfosten als Eigenantrieb gestaltet. Das verrückteste Big LUUPZ® ist aber der Breakdancer, bei dem sich auf der rotierenden Haupt-scheibe auch die drei LUUPZ®-Kugeln drehen - wie beim echten Breakdancer auf dem Rummel.

The new Big LUUPZ® carousel concept is the systematic technical development of the popular and proven PLAYPARC carousels for classic but also floor-level installation. With the unique Big LUUPZ® tub system (BLWS), which simultaneously serves as a foundation, the floor-level installation of all carousels is child's play. In the TIVOLI or BREAKDANCER models, the central post is designed as a self-propelled unit. The craziest Big LUUPZ®, however, is the Breakdancer, where the three LUUPZ® balls also rotate on the rotating main disc - like the real breakdancer at the circus.

Big LUUPZ® Wannensystem
Big LUUPZ® tub system



Mit BLWS-Fertigfundament für unkomplizierte Montage. With BLWS prefabricated foundation for easy installation.



Big LUUPZ® Bodenanker
Big LUUPZ® ground anchor



Mit Erdanker zum Einbetonieren. With ground anchor to set in concrete.



1	MODELL MODEL	 TIBUR 02.05.090	 TIVAT 02.06.123	 TIVOLI 02.06.120	 BREAKDANCER 02.06.125
2	GRUNDPLATTE BASE PLATFORM				
3	VERANKERUNG MOUNTING	 Big LUUPZ® Wannensystem Big LUUPZ® tub system		 Big LUUPZ® Bodenanker Big LUUPZ® ground anchor	





FEDERGERÄTE UND KARUSSELLE

SPRING ROCKERS AND CAROUSELS

VOGELNEST AUF FEDERN

BIRD'S NEST SPRINGER

15.06.135

⊕ Ø 1,30 m ⊕ Ø 4,30 m ⊕ 0,85 m

⊕ 1,00 ⊕ 3+



FEDERPLATTE Ø 100 CM

PLATFORM WITH SPRINGS Ø 100 CM

mit 3 Federn with 3 Springs

11.04.305

⊕ Ø 1,00 m ⊕ Ø 4,00 m ⊕ 0,42 m

⊕ 0,42 m ⊕ 4+



NAUTILUS II

01.25.505 HPL-EDELSTAHL HPL-STAINLESS STEEL

01.25.510 HOLZ-EDELSTAHL WOOD STAINLESS STEEL (O. ABB. NO PIC.)

⊕ 3,41 x 0,92 m ⊕ 6,92 x 4,44 m ⊕ 3,41 m

⊕ 0,92 m ⊕ 4+



FEDERPLATTE Ø 40 CM

PLATFORM WITH SPRING Ø 40 CM

12.05.085

⊕ Ø 0,40 m ⊕ 3,40 m ⊕ 0,42 m

⊕ 0,42 m ⊕ 3+

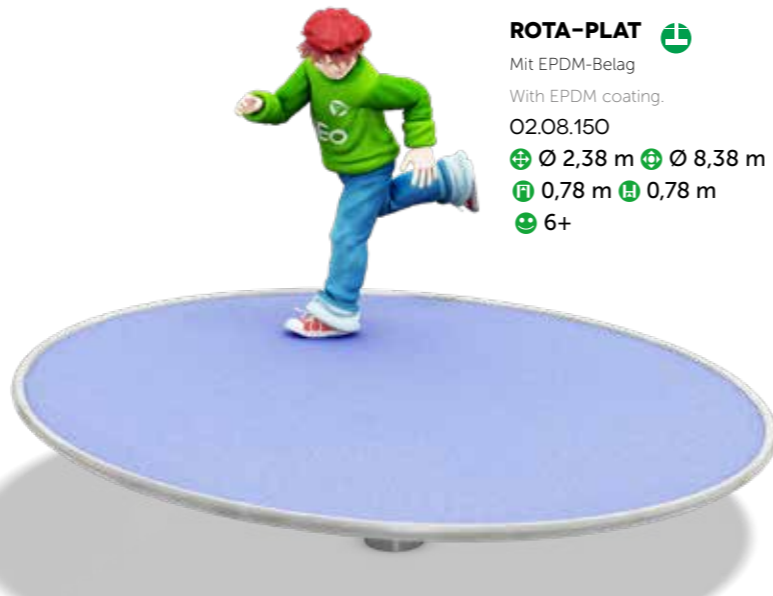

ROTA-PLAT

Mit EPDM-Belag

With EPDM coating.

02.08.150

⊕ Ø 2,38 m ⊕ Ø 8,38 m

⊕ 0,78 m ⊕ 0,78 m

⊕ 6+

WIPPGERÄTE

SEESAWS



FALLNIX

Edelstahl stainless steel

02.01.024

⊕ 3,00 x 0,75 m

⊕ 5,00 x 2,75 m

⊕ 1,26 m ⊕ 0,95 m

⊕ 4+



HIP-HOP SURFER

15.30.011

⊕ Ø 1,90 x 1,10 m (oval)

⊕ Ø 5,90 m ⊕ 2,80 m

⊕ 1,00 m ⊕ 6+



SOZIONIX

02.01.026

⊕ 1,45 x 0,35 x 1,53 m

⊕ 4,82 x 3,36 m

⊕ 1,53 m ⊕ 0,90 m

⊕ 4+



HIP-HOP FLASH

15.30.021

⊕ Ø 1,90 x 1,10 m (oval)

⊕ Ø 5,90 m ⊕ 1,00 m ⊕ 6+

HIP-HOP BASIS

15.30.001

⊕ Ø 1,90 m

⊕ Ø 5,90 m

⊕ 1,00 m

⊕ 6+





SEILBAHNEN ROPE RAILS



SEILBAHN MIT STARTRAMPE CABLE CAR WITH LAUNCH PLATFORM

O2.10.176 VERZINKT ZINCED
 ⊕ 21,40 x 4,54 m ⊕ 23,17 x 4,00 m ⊕ 3,69 m
 ⊕ 1,36 m 😊 6+, Seillänge 20 m Rope length 20



Seilbefestigung mittels linearer, selbst-hemmender Spannvorrichtung!
 Das gewährleistet eine einfache Seilmon-tage (ohne große Hilfsmittel) und für die Unterhaltung, eine einfache Seilspannung bzw. späteren Austausch.

Rope attachment by means of linear, self-locking tensioning device! This ensures easy rope installation (without large tools) and for the maintenance, a simple rope tension or later times exchange.

SEILBAHN FÜR HANGLAGE CABLE CAR FOR SLOPE

O2.09.166 VERZINKT ZINCED
 ⊕ 21,10 x 4,14 m ⊕ 22,89 x 4,00 m ⊕ 3,22 m
 ⊕ 1,36 m 😊 6+, Seillänge 20 m Rope length 20



SEILBAHN FÜR ERDHÜGEL CABLE CAR FOR HILL

O2.10.186 VERZINKT ZINCED
 ⊕ 21,40 x 4,54 m ⊕ 23,17 x 4,00 m ⊕ 3,69 m
 ⊕ 1,36 m 😊 6+, Seillänge 20 m Rope length 20



Optional mit pulverbeschichtetem Stahl (RAL-Farben) erhältlich.

RAL5015 **RAL1016** **RAL6017** **RAL2005** **RAL3002** **RAL9017**

Optionally available with powder-coated steel (RAL colors)

Sonderfarben auf Anfrage / special colors on request



Unsere Sonnensegel sind der perfekte Sonnen- und Sichtschutz: Für die Terrasse, den Garten, zum Beschatten von Kinderspielbereichen oder Spielgeräten im Kindergarten.

Our sun-shadings are the perfect sun protection: for terraces, garden or shading play areas in kindergardens.



HARENA 19
09.05.119

ARTIKEL ITEM	ABMESSUNGEN SEGEL DIMENSIONS SUN-SHADING	PFOSTEN, METALL VERZ. POSTS, METAL ZINCED	FARBEN COLOUR
11.11.240	3,00 X 3,00 M	4 Stck. 1,5 Zoll inkl. Bodenhülse 4 pcs. 1.5 inch incl. Ground sleeve	rot, creme, blau, dunkelgrün, hellgrün, orange,
11.11.241	4,00 X 4,00 M	4 Stck. 1,5 Zoll inkl. Bodenhülse Mittelverspannung 4 pcs. 1.5 inch incl. ground sleeve central tensioning	terrakotta, silber, weiß
11.11.242	5,00 X 5,00 M	8 Stck. 1,5 Zoll inkl. Bodenhülse Mittelverspannung 8 pcs. 1.5 inch incl. ground sleeve central tensioning	red, cream, blue, dark green, light green,
11.11.243	6,00 X 6,00 M	9 Stck. 1,5 Zoll inkl. Bodenhülse Mittelverspannung 9 pcs. 1.5 inch incl. ground sleeve central tensioning	orange, terracotta, silver, white



Konstruktionsänderungen vorbehalten. Farbabweichungen möglich.
 Design changes reserved. Color differences possible.



SANDKÄSTEN

FÖRDERN VON KREATIVITÄT UND SOZIALEM MITEINANDER

SANDBOXES

SUPPORT CREATIVITY AND SOCIAL INTERACTION



Für Kleinkinder hat ein Sandkasten einen unwiderstehlichen Aufforderungscharakter. Von Kuchenbacken bis Burgenbau ist ein Sandkasten mit Spielsand die ideale Bühne, um der individuellen Kreativität Raum zu geben. Kommt dann auch noch Wasser ins Spiel, sind Kinder zwischen 1 und 5 Jahren kaum zu halten. Der Rolli-Sandkasten bietet zusätzlich Kindern mit Einschränkungen die Möglichkeit, am gemeinsamen Spiel wie selbstverständlich teilzunehmen.

For small children, a sandbox has an irresistible challenge character. From baking cakes to building castles is a sandbox with play sand the ideal stage to give room to individual creativity. If water comes into play, children between 1 and 5 years of age are hardly to be held. The wheel chair sandbox also offers children with disabilities the opportunity to take part in joint games as if they were their own.



SANDKISTE
SANDBOX
 11.10.227
 ⊕ 2,50 x 2,50 x 0,29 m
 ⊞ 0,29 m 😊 3+

🌿 ♻️ 🗑️ 🚰 🧯 🚰



SANDKASTEN MIT SCHIEBARER ABDECKUNG AUF ROLLEN
SANDBOX WITH SLIDING COVER
 11.11.233
 ⊕ 6,17 x 3,32 x 0,44 m ⊕ 9,20 x 6,20 m
 ⊞ 0,44 m ⊞ 0,44 m 😊 3+

🌿 ♻️ 🗑️ 🚰 🧯 🚰



SANDKASTEN
SANDBOX SQUARED TIMBER
KANTHOLZ (3 LAGEN JE 9 X 9 CM STARK)
(3 LAYERS, EACH 9 X 9 CM)
 11.11.231 ⊕ 2,00 x 2,00 x 0,27 m
 11.11.232 ⊕ 3,00 x 3,00 x 0,27 m
 ⊞ 0,27 m 😊 3+

🌿 ♻️ 🗑️ 🚰 🧯 🚰



SANDKASTEN OKTAGON
SANDBOX OCTAGON
 11.11.234
 ⊕ 2,90 x 2,90 x 0,27 m ⊕ 6,00 x 6,00 m
 ⊞ 0,27 m 😊 3+

🌿 ♻️ 🗑️ 🚰 🧯 🚰

ROLLI-SANDKASTEN
WHEELCHAIR SANDBOX
 11.10.240
 ⊕ 4,60 x 2,96 m ⊕ 7,60 x 5,95 m
 ⊞ 0,65 m ⊞ 0,65 m 😊 3+

🌿 ♻️ 🗑️ 🚰 🧯 🚰





Gilt für alle Abbildungen auf dieser Doppelseite
Applies to all images on this double page

3+



PONY
11.20.010



DOPPELBEATLE
11.20.601



TUK-TUK
11.20.615



TANDEM DOLY
11.20.500



BUGGY
11.20.620



DINO
11.20.030



BEATLE
11.20.480



FISCH
11.20.060



TANDEM PONY
11.20.100



MOTORRAD
11.20.040



TANDEM DINO
11.20.300



DOPPELFISCH
11.20.600



PIEPMATZ
11.20.050



GLÜCKSKLEE
11.20.070



FROSCH
11.20.080



TANDEM HUND
11.20.200



TANDEM ROLLY
11.20.610



HOLZWIPPE

SEESAW WOOD

02.01.011 zweisitzig two-seater

02.01.010 viersitzig four-seater.

⊕ 4,00 x 0,21 m ⊕ 7,00 x 3,14 m

Ⓜ 0,69 m Ⓜ 1,45 m 😊 3+



METALLWIPPE, VIERSITZIG

SEESAW METAL, FOUR SEATS, ZINCED

02.02.030 verzinkt zincod

⊕ 4,12 x 0,23 m ⊕ 7,12 x 3,23 m

Ⓜ 0,72 m Ⓜ 1,45 m 😊 3+



METALLWIPPE, ACHTSITZIG

SEESAW METAL, EIGHT SEATS, ZINCED

02.02.040 verzinkt zincod

⊕ 4,12 x 1,35 m ⊕ 7,12 x 4,35 m

Ⓜ 0,92 m 😊 3+





SCHAUKELN

SPIELPLATZ-KLASSIKER

SWINGS

CLASSIC PLAYGROUND EQUIPMENT



SESSEL-SCHAUKEL

EASY CHAIR SWING

mit Sessel Maxi, 1-fach with easy chair Maxi
07.01.101 verzinkt zined
07.01.100 Metall/Holz metal/wood
⊕ 4,21 x 2,16 m ⊕ 6,18 x 2,05 m



SESSEL-SCHAUKEL-KOMBI

EASY CHAIR SWING COMBI

inkl. Sitze und Sessel Maxi
incl. seats and easy chair Maxi
07.02.100 Metall/Holz metal/wood
07.02.101 Metall/Holz metal/wood
⊕ 7,31 x 2,16 m ⊕ 8,14 x 5,61 m
⊕ 2,63 m ⊕ 1,50/1,58 m ☺ 3+



SESSEL-SCHAUKEL-ANBAU

EASY CHAIR SWING-ADD ON

mit Sessel Maxi with easy chair Maxi
09.29.500 Metall/Holz o. ABB
metal/wood w. pic
09.29.501 verzinkt zined
☺ 3+



SCHAUKELBETT-SCHAUKEL

SWING BED SWING

07.09.100 verzinkt zined
⊕ 4,21 x 2,16 x 2,66 m ⊕ 8,20 x 2,25 m
⊕ 1,60 m ☺ 3+

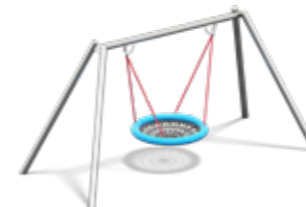

VOGELNESTSCHAUKEL

BIRD'S NEST SWING

07.08.161
⊕ 2,20 m Holz/Metall wood/metal

07.08.160
⊕ 2,60 m Holz/Metall wood/metal

07.08.166
⊕ 2,20 m Metall metal

07.08.165
⊕ 2,60 m Metall metal



VIERTFACH-SCHAUKEL

QUADRUPLE SWING

07.02.060
⊕ 2,20 m Holz/Metall wood/metal

07.02.061
⊕ 2,60 m Holz/Metall wood/metal

07.02.065
⊕ 2,20 m metall/Metall Metal (o.ABB. w.pic)

07.02.066
⊕ 2,60 m metall/Metall Metal (o.ABB. w.pic)



KOMBI-SCHAUKEL MIT VOGELNEST

COMBINED SWING WITH BIRD'S NEST

07.02.070
⊕ 2,20 m Holz/Metall wood/metal

07.02.071
⊕ 2,60 m Holz/Metall wood/metal

07.02.075
⊕ 2,20 m metall/Metall metal (o.ABB. w. pic)

07.02.076
⊕ 2,60 m metall/Metall metal (o.ABB. w.pic)



SCHAUKEL-INFERNO-KOMBINATION

SWING INFERNO COMBINATION

07.02.080 Holz/Metall wood/metal
⊕ 12,50 x 3,80 x 2,65 m ⊕ 8,14 x 12,50 m
⊕ 1,48 m ☺ 3+



HÄNGEMATTE HAMMOCK

07.07.161 VERZINKT ZINCED
⊕ 4,36 x 0,80 m ⊕ 4,76 x 4,00 m
⊕ 1,74 m ⊕ 1,37 m ☺ 4+

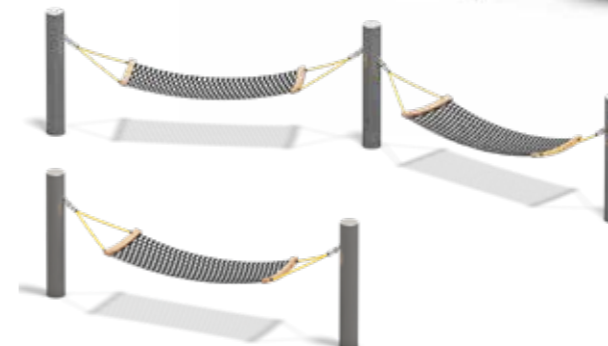

TANDEM HÄNGEMATTE TANDEM HAMMOCK

07.07.162 VERZINKT ZINCED
⊕ 7,95 x 2,86 m ⊕ 8,79 x 5,42 m
⊕ 1,74 m ⊕ 0,60 m ☺ 4+





MINI TAMPEN-SCHAUKEL
MINI ROPE-SWING
15.06.139
⊕ 3,10 x 1,10 m ⊕ 6,10 x 4,10 m
Ⓜ 1,20 m Ⓜ 0,80 m 😊 3+



SUPER-TAMPEN-SWINGER MIDI
VICTORY ROPE SWINGER
15.06.173
⊕ 5,50 x 8,60 m ⊕ 5,50 x 12,75 m
Ⓜ 2,95 m Ⓜ 1,50 m 😊 4+



SUPER-TAMPEN-SWINGER
RABENSCHIED
VIKING SUPER ROPE-SWINGER
15.06.170 Douglasie
⊕ 10,70 x 4,05 m ⊕ 14,10 x 4,05 m
Ⓜ 3,55 m Ⓜ 0,50 m 😊 4+



SECHSECKSCHAUKEL
HEXAGON SWING
07.06.125 verzinkt zined
07.06.126 verzinkt/pulverbeschichtet zin-
ced/ powdercoated (o.ABB. w.pic)
⊕ Ø 5,30 m ⊕ 12,06 x 11,38 m
Ⓜ 2,49 m Ⓜ 1,40 m 😊 4 +



3 Plätze
3 seats

SUPER-TAMPEN-SWINGER MINI
GONDOLAROPE-SWINGER
15.06.172
⊕ 3,10 x 1,10 m ⊕ 6,10 x 4,10 m
Ⓜ 1,20 m Ⓜ 0,80 m 😊 4+



SUPER-TAMPEN-SWINGER
RABENSCHIED MAXI
VIKING SUPER ROPE-SWINGERMAXI
15.06.171
⊕ 17,50 X 8,50 m x 4,05 m ⊕ 14,10 x 4,05 m
Ⓜ 5,30 m Ⓜ 0,50 m 😊 4+

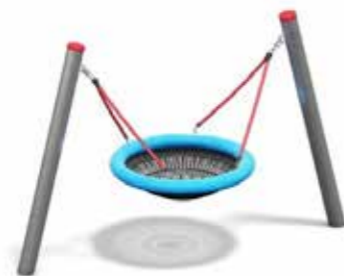

MINI-VOGELNEST-SCHAUKEL
MINI HONEYCOMB SWING
07.01.720
⊕ 3,00 x 0,80 x 2,40 m ⊕ 6,30 x 2,30 m
Ⓜ 1,45 m Ⓜ 1,45 m 😊 1+



KLEINKINDER-
SCHAUKELSITZ
TODDLERS SWING SEAT
26.02.002



ELTERN-KIND-
SCHAUKELSITZ
PARENTS-KID SWING SEAT
16.04.504



2 Plätze
2 seats

MINI TAMPEN-SCHAUKEL
MINI ROPE-SWING
15.06.139
⊕ 3,10 x 1,10 m ⊕ 6,10 x 4,10 m
Ⓜ 1,20 m Ⓜ 0,80 m 😊 3+



SCHWEBENDES VOGELNEST
SWINGING HONEYCOMB NEST
15.06.138
⊕ 3,10 x 1,10 m ⊕ Ø 4,10 Ⓜ 1,30 m
Ⓜ 0,55 m 😊 3+ / Rollifahrer



ROTO
02.04.075 verzinkt zined
⊕ 5,00 x 1,62 m ⊕ Ø 8,28 m Ⓜ 3,12 m
Ⓜ 1,58 m 😊 ab 6 Jahre





RUTSCHEN

SPIELPLATZ-KLASSIKER

SLIDES

CLASSIC PLAYGROUND EQUIPMENT

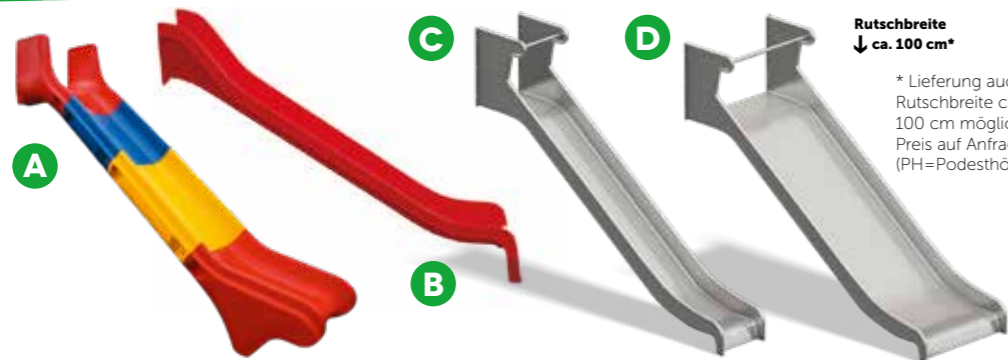

Rutschbreite
↓ ca. 100 cm*

* Lieferung auch in Rutschbreite ca. 100 cm möglich. Preis auf Anfrage. (PH=Podesthöhe)

Detail Schalldämmung

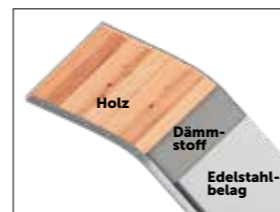

Detail sound insulation

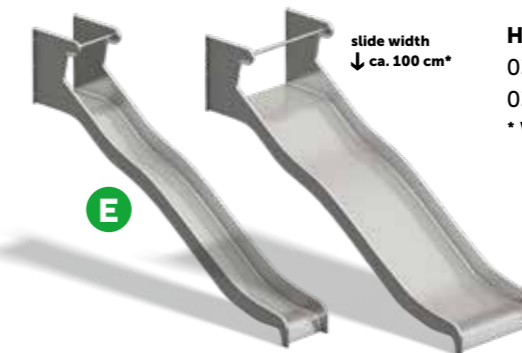

slide width
↓ ca. 100 cm*

HILL PLATFORM, PH 25 CM
03.01.005 for slide 50 cm width
03.01.008 for slide 100 cm width*
* WITHOUT PICTURE

* Delivery also possible with a width of ca. 100 cm
Price upon request. (PH=Platform height)



TYP	RUTSCHBREITE CA. 50 CM	PH=90 -100CM	PH=120 -130CM	PH=145 -155CM	PH=175 -185CM	PH=195 -205CM	PH=220 -230CM	PH=245 -250CM
A	PE-SEGMENTRUTSCHE	-	25.04.100	25.04.101	25.04.102	25.04.103	-	25.04.104
B	GFK-RUTSCHE zum Anflanschen	-	25.04.127	25.04.128	25.04.129	25.04.130	-	-
C	NEOSPIEL SCHALLGED. RUTSCHE Rutschbelag: V2A Seitenwangen: verzinkt	03.03.100*	03.03.125*	03.03.150*	03.03.175*	03.03.200*	03.03.225*	03.03.250*
D	NEOSPIEL SCHALLGED. GANZ-EDELSTAHL-RUTSCHE Rutschbelag: V2A Seitenwangen: V2A	03.03.103*	03.03.128*	03.03.153*	03.03.178*	03.03.203*	03.03.228*	03.03.253*
E	NEOSPIEL SCHALLGED. RUTSCHE MIT WELLE Rutschbelag: V2A Seitenwangen: verzinkt	-	-	03.05.350*	03.05.353*	03.05.365*	03.05.356*	03.05.368*
F	LEITERNAUFSTIEG METALL FÜR TYP C- E	03.03.104	03.03.129	03.03.154	03.03.179	03.03.204	-	-
G	NATURHOLZAUFGANG FÜR TYP A-E	03.02.100	03.02.125	03.02.150	03.02.175	03.02.200	03.02.225	03.02.250



TYPE	SLIDE WIDTH CA. 50 CM	PH=90 -100CM	PH=120 -130CM	PH=145 -155CM	PH=175 -185CM	PH=195 -205CM	PH=220 -230CM	PH=245 -250CM
A	PE-SEGMENT SLIDE	-	25.04.100	25.04.101	25.04.102	25.04.103	-	25.04.104
B	GRP-SLIDE for flange mounting	-	25.04.127	25.04.128	25.04.129	25.04.130	-	-
C	NEOSPIEL SILENCED SLIDE cover: stainless steel sides: zincd	03.03.100*	03.03.125*	03.03.150*	03.03.175*	03.03.200*	03.03.225*	03.03.250*
D	NEOSPIEL SILENCED SLIDE, COMPLETE STAINLESS STEEL cover: stainless steel sides: stainless steel	03.03.103*	03.03.128*	03.03.153*	03.03.178*	03.03.203*	03.03.228*	03.03.253*
E	NEOSPIEL SILENCED SLIDE WITH WAVE cover: stainless steel sides: zincd	-	-	03.05.350*	03.05.353*	03.05.365*	03.05.356*	03.05.368*
F	LADDER ACCESS METAL FOR TYPE C- E	03.03.104	03.03.129	03.03.154	03.03.179	03.03.204	-	-
G	NATURAL WOOD ACCESS FOR TYPE A-E	03.02.100	03.02.125	03.02.150	03.02.175	03.02.200	03.02.225	03.02.250



PE-RÖHREN-RUTSCHE, GERADE

PE TUBE SLIDE, STRAIGHT

Besteht aus Segmenten, die durch den außenliegenden Flansch verbunden werden. Der Innendurchmesser beträgt ca. 75 cm. Die Rutschen sind gelb/rot und werden je nach Größe vor- oder teilmontiert geliefert. Composed of segments that are connected by an outer flange. The inner diameter is approximately 75 cm. The slides are yellow / red and depending on the size delivered completely or partially assembled.

25.04.140 1,25 m

25.04.141 1,50 m

25.04.142 2,00 m

Ab PH 2,50 m inkl. Mittelstütze
As of PH 2.50 m incl. central support

25.04.143 2,50 m

25.04.144 3,00 m



PE-RÖHREN-RUTSCHE

PE TUBES SLIDE

03.09.500

Lieferbar mit 0,75 m Durchmesser. Wird in einzelnen Segmenten als Flanschverbindung zusammengesetzt. Farben: gelb/rot/grün/blau.

Available with 0.75 m diameter. Composed of individual segments colour: yellow/red/green/blue.



MINI-M-RUTSCHE

MINI-M-SLIDE

15.06.247 verzinkt zinned

3,00 x 2,35 m 6,30 x 5,35 m

1,75 m 1,00 m 3+



3ER-PARCOUR MIT RUTSCHE

TRIPLE PLAY COURSE WITH SLIDE

15.06.249 verzinkt zinned

6,40 x 5,80 m 9,60 x 9,35 m

2,65 m 1,00 m 3+



MINI-EIGER

30.06.015 edelstahl stainless steel

1,21 x 0,95 x m 4,21 x 3,95 m

0,60 m 0,60 m U-3 Jahre



SPATZENNEST MIT RUTSCHE

SPARROW'S NEST WITH SLIDE

15.06.153 Rutsche grün o. rot

Slide green or red

1,65 x 2,90 m 5,80 x 4,60 m

0,85 m 0,55 m 3+



ADLERHORST ASSLAR

LITTLE EAGLE'S NEST

15.06.163

3,70 x 2,55 m 6,95 x 4,85 m 1,70 m

1,00 m 4+





NIMMERLAND
04.11.050 Natur Natural
04.11.051 Farbige Coloured
⊕ 9,94 x 5,06 m ⊕ 12,66 x 8,06 m
Ⓜ 3,33 m Ⓜ 1,50 m 😊 3+



Das ZWERGENLAND ist eine Produktlinie, die das kindliche Spiel durch seine verwinkelte und nicht symmetrische Bauweise zusätzlich anregt. Es macht den Zwergen einfach Spaß und Freude zu laufen, klettern, rutschen und Verstecken zu spielen. Das ZWERGENLAND ist speziell für Kinder zwischen 1 und 6 Jahren konzipiert.

The DWARF'S LAND is a product line that additionally stimulates children's play due to its winding and non-symmetrical design. It is simply fun and joy for the dwarves to run, climb, slide and play hide and seek. The DWARF'S LAND product line is specially designed for children between 1 and 6 years.



ZWERG
DWARF HOUSE
04.11.200 Natur natural
04.11.210 farbig coloured
⊕ 1,83 x 1,75 m ⊕ 4,78 x 4,75 m
Ⓜ 1,97 m 😊 3+



ZWERG MIT VERANDA
DWARF HOUSE WITH PORCH
04.11.220 Natur natural
04.11.230 farbig
⊕ 2,32 x 2,12 m ⊕ 5,32 x 4,98 m
Ⓜ 2,58 m Ⓜ 0,75 m 😊 3+



ZWERGENBAND
DWARF BELT
04.11.248 natur natural
04.11.249 farbig coloured
⊕ 3,61 x 1,75 m ⊕ 6,58 x 4,75 m Ⓜ 2,58 m
Ⓜ 0,75 m 😊 3+



ZWERGENWALD DWARF FOREST
04.11.246 natur natural
04.11.247 farbig (o. Abb.) colored (no pic.)
⊕ 6,45 x 3,12 m ⊕ 9,45 x 6,13 m
Ⓜ 2,65 m Ⓜ 0,75 m 😊 3+



ZWERGENRUTSCHE
DWARF SLIDE
04.11.232 natur natural
04.11.233 farbig coloured
⊕ 3,51 x 2,52 m ⊕ 7,00 x 5,52 m
Ⓜ 2,65 m Ⓜ 0,75 m 😊 3+



ZWERGENBAUMHAUS
DWARF TREE HOUSE
04.11.244 natur (o. Abb.)
nature (not shown)
04.11.245 farbig coloured
⊕ 2,91 x 2,10 m ⊕ 6,41 x 5,08 m
Ⓜ 2,58 m Ⓜ 0,75 m



OBERON
04.11.238 natur natural
04.11.239 farbig Coloured
⊕ 7,42 x 4,14 m ⊕ 10,42 x 7,57 m
Ⓜ 3,33 m Ⓜ 1,50 m 😊 3+



ALBERICH
ALBERICH
04.11.240 natur (o. Abb.)
nature (not shown)
04.11.241 farbig coloured
⊕ 4,86 x 4,09 m ⊕ 7,60 x 7,48 m Ⓜ 3,33 m
Ⓜ 1,50 m





HUNAMOG

04.11.258

⊕ 2,91 x 1,40 m ⊕ 5,91 x 4,30 m

Ⓜ 2,17 m Ⓜ 0,99 m 😊 3+



ORIENT-LOK

ORIENT LOCO

11.15.200 Lok loco

⊕ 3,81 x 1,10 m ⊕ 6,80 x 4,0 m

Ⓜ 2,39 m Ⓜ 0,90 m 😊 3+

ORIENT-WAGON

ORIENT WAGON

11.15.210 Wagen car

⊕ 1,60 x 1,10 m ⊕ 4,59 x 4,04 m

Ⓜ 2,39 m Ⓜ 0,90 m 😊 3+



KRIECHTUNNEL

01.01.110

2,0 m lang mit 2 Sicherungsbrüstungen

CRAWLING TUNNEL 2.0 m with 2

securing parapets

⊕ 2,07 x 1,20 m ⊕ 5,04 x 1,20 m

Ⓜ 1,17 m 😊 4+



SPITZHAUS I

04.02.040

⊕ 2,05 x 1,85 m ⊕ 5,03 x 4,85 m

Ⓜ 1,84 m Ⓜ 0,19 m 😊 3+



SPITZHAUS II

04.03.060

⊕ 2,77 x 2,23 m ⊕ 5,77 x 5,23 m

Ⓜ 2,26 m Ⓜ 0,94 m 😊 3+



KATE

04.11.190 Natur (o. Abb.) Nature (no pic.)

04.11.180 HPL-Dach, HPL-roof

⊕ 2,00 x 1,43 m ⊕ 4,93 x 4,20 m

Ⓜ 1,82 m Ⓜ 0,15 m 😊 3+



KOTTEN I

04.11.185

HPL-Dach, HPL-roof

⊕ 2,00 x 1,43 m ⊕ 4,93 x 4,20 m

Ⓜ 1,82 m Ⓜ 0,15 m 😊 3+



KOTTEN II

04.11.170

⊕ 3,00 x 2,54 m ⊕ 6,00 x 5,31 m

Ⓜ 1,85 m Ⓜ 0,14 m 😊 3+



SCHOBER

04.08.128

⊕ 4,64 x 2,02 m ⊕ 8,06 x 4,50 m

Ⓜ 3,10 m Ⓜ 1,00 m 😊 3+

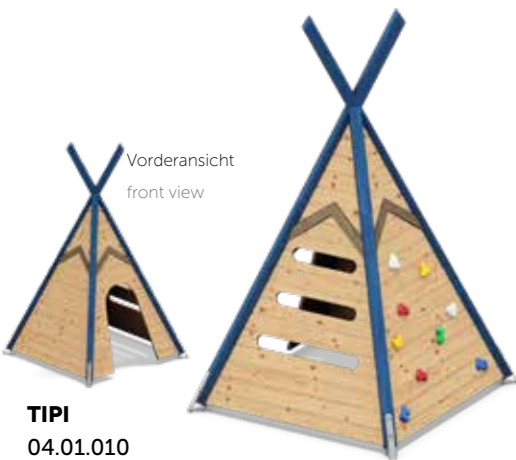

TIPI

04.01.010

⊕ 1,32 x 1,31 m ⊕ 4,32 x 4,31 m

Ⓜ 2,45 m Ⓜ 0,95 m 😊 4+





KLETTERN HANGELN SPIELEN

FÜR KINDER AB 4 JAHREN

CLIMB HANG PLAY

FOR CHILDREN FROM 4 YEARS ON



GAIDAMAR

05.09.375 VERZINKT ZINCED
05.09.376 PULVERBESCHICHTET (OHNE BILD)
POWDERCOATED (WITHOUT PIC.)
⊕ 6,89 m x 1,31 m ⊕ 10,38 x 5,02 m ⊕ 2,60 m
⊕ 2,50 m 😊 4+



WICHMANN I

05.20.310
⊕ 4,06 x 0,85 x 2,60 m ⊕ 7,61 x 3,88 m
⊕ 2,60 m ⊕ 1,60 m 😊 4+

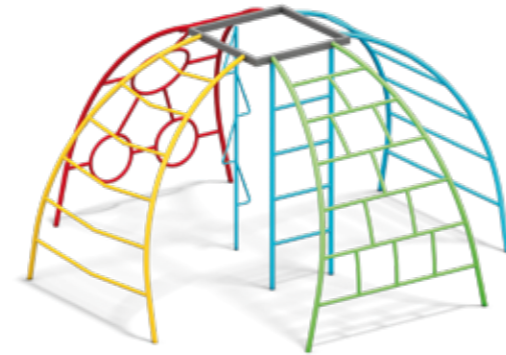

MONT BLANC

40.05.010 VERZINKT PULVERBESCHICHTET
ZINCED POWDERCOATED
⊕ Ø 2,83 m ⊕ Ø 7,10 m ⊕ 1,70 m
⊕ 1,70 m 😊 5+



AMELUNG

08.20.550
⊕ 5,14 x 4,00 m ⊕ 7,37 x 5,14 m ⊕ 3,48 m ⊕ 1,50 m 😊 4+



DODIKO RÜCKANSICHT

DODIKO

08.20.560
⊕ 7,66 x 4,37 m ⊕ 11,36 x 7,57 m ⊕ 2,70 m ⊕ 1,79 m 😊 4+



WALDRED

05.09.370 VERZINKT PULVERBESCHICHTET
GALVANIZED/POWDER-COATED
⊕ 9,40 x 2,90 m ⊕ 13,09 x 6,65 m
⊕ 2,28 m ⊕ 2,12 m 😊 4+

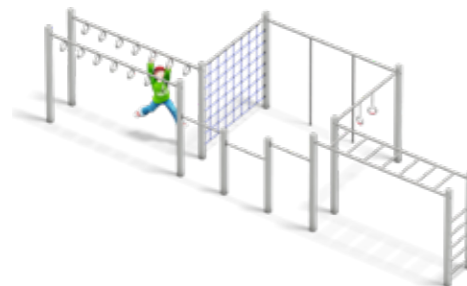

WALDRED II

05.09.378
VERZINKT ZINCED
⊕ 9,40 x 2,90 m ⊕ 13,09 x 6,65 m
⊕ 2,28 m ⊕ 2,12 m 😊 4+



WALDRED III

05.09.374 VERZINKT PULVERBESCHICHTET
GALVANIZED/POWDER-COATED
⊕ 9,40 x 2,90 m ⊕ 13,09 x 6,65 m
⊕ 2,28 m ⊕ 2,12 m 😊 4+



BILLUNG

08.20.540
⊕ 5,64 x 2,94 m ⊕ 9,15 x 6,72 m ⊕ 2,56 m ⊕ 2,56 m 😊 4+



BILLUNGBONG

08.20.540.001
⊕ 8,13 x 3,91 x 2,56 m ⊕ 11,51 x 6,72 m ⊕ 2,56 m ⊕ 2,56 m 😊 4+



KLETTERN HANGELN SPIELEN

FÜR KINDER AB 4 JAHREN

CLIMB HANG PLAY

FOR CHILDREN FROM 4 YEARS ON



THANKMAR

05.09.195

VERZINKT (O. ABB.) ZINCED (WITHOUT PIC.)

05.09.196

VERZINKT / PULVERBESCHICHTET

ZINCED / POWDERCOATED

⊕ 3,52 x 3,07 x 2,28 m

⊕ 7,21 x 6,63 m

📏 2,12 m 😊 ab 4 Jahre



BRUN

07.04.090

⊕ 6,48 x 5,58 m ⊕ 9,98 x 8,69 m

📏 2,76 m 📏 2,24 m 😊 4+



THIETMAR

05.09.205

⊕ Ø 2,76 m ⊕ Ø 6,70 m

📏 2,26 m 📏 2,26 m

😊 ab 4 Jahr



GERBEGA

05.06.130

⊕ 2,50 x 0,14 m ⊕ 6,48 x 4,14 m

📏 2,24 m 📏 2,24 m 😊 4+



HADALDA

04.02.031

⊕ 1,78 x 1,72 m ⊕ 4,78 x 4,72 m

📏 1,54 m 📏 1,44 m 😊 2+



THEOBALD

05.09.200

⊕ Ø 4,80 m ⊕ Ø 7,90 m

📏 2,37 m 📏 2,37 m 😊 4+



SPROSSENWAND MIT RECK

WALL BARS WITH BARS

05.04.100

⊕ 4,09 x 0,15 m ⊕ 7,09 x 3,64 m

📏 1,96 m 📏 1,96 m 😊 4+

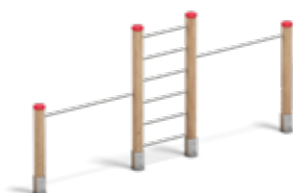

EINFACHRECK

SINGLE BAR

12.02.066

Reckstange, 1,30 m Höhe

Horizontal bar, 1,30m height

⊕ 1,70 x 0,10 m

⊕ 4,90 x 3,10 m

📏 1,36 m 📏 1,30 m

😊 4+

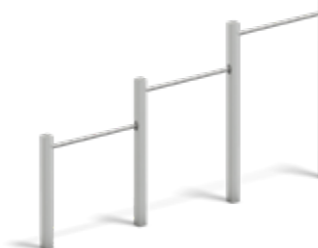
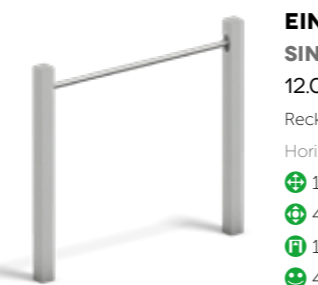

DREIERRECK TRIPLE BARS

12.02.064 METALL VERZINKT METAL ZINCED

12.02.060 HOLZ WOOD

⊕ 4,90 x 0,10 m ⊕ 8,10 x 3,50 m

📏 1,86 m 📏 1,80 m 😊 ab 4 Jahre

Höhen / heights: 0,80/1,30/1,80 m

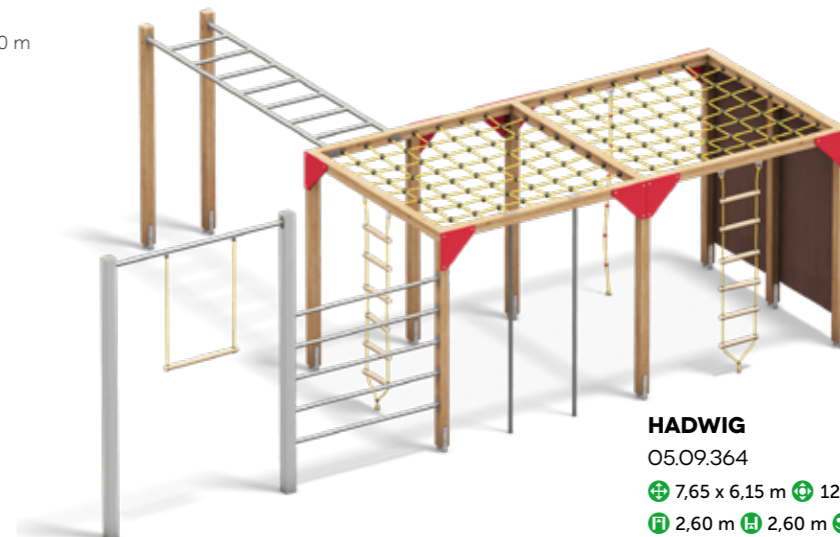

ASIK

05.05.910

⊕ 8,55 x 1,82 m ⊕ 11,58 x 4,93 m

📏 1,75 m 📏 1,50 m 😊 3+



HILDGER

05.08.185

⊕ 3,44 x 2,41 m ⊕ 7,36 x 6,46 m

📏 2,31 m 📏 2,31 m 😊 4+



HADWIG

05.09.364

⊕ 7,65 x 6,15 m ⊕ 12,15 x 10,96 m

📏 2,60 m 📏 2,60 m 😊 4+

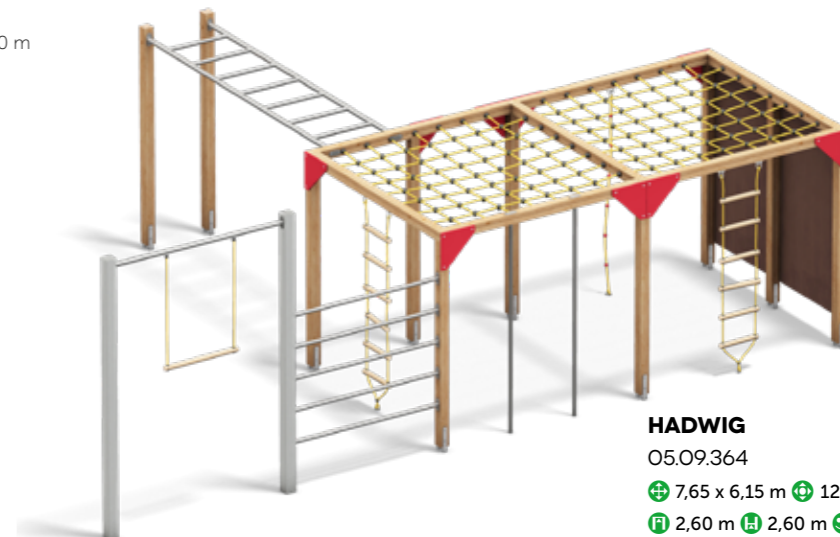



INSPIRATION

SPIELPLATZ-ATTRAKTIONEN

INSPIRATION

PLAYGROUND ATTRACTIONS





MULTISPIELANLAGEN

SPIELTÜRME



Klassische Multispielanlagen werden bei PLAYPARC mit Standpfosten aus unbehandeltem Lärchenholz (Holz) oder aus Edelstahl (Ferrum) gefertigt. Die Modularität der Spielplatzgeräte und der Spielspaß für die Kinder bleiben unabhängig von der Materialwahl gleich.

Classic multi-playground equipment at PLAYPARC is manufactured with stand posts made of untreated larch wood (wood) or stainless steel (ferrum). The modularity of the playground equipment and the fun for the children remain the same regardless of the material.

MULTIPLAY UNITS

PLAY TOWERS



KATZOHLBACH
09.24.858 Holz wood
⊕ 15,51 x 6,14 m
⊕ 19,03 x 9,83 m
⊖ 6,57 m ⊕ 3,25 m
😊 ab 5 Jahre



NÜRNBERG
09.24.710 Holz wood
09.24.721 Ferrum o. Abb. no pic.
⊕ 3,31 x 2,89 m ⊕ 6,31 x 5,80 m
⊖ 3,94 m ⊕ 1,50 m 😊 4 +

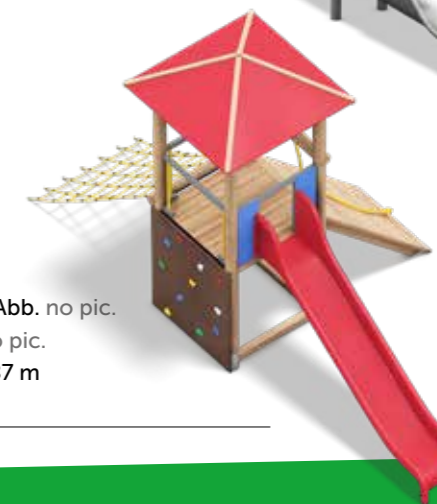

PASSAU
09.24.680 Holz wood
09.24.681 Ferrum/Holz wood o. Abb. no pic.
09.24.682 Ferrum/HPL o. Abb. no pic.
⊕ 5,06 x 2,90 x 3,94 ⊕ 8,54 x 5,87 m
⊖ 3,94 m ⊕ 1,50 m 😊 4 +



MULTISPIELANLAGEN SPIELTÜRME

MULTIPLAY UNITS PLAY TOWERS



HAMBURG

09.24.848

Holz wood

⊕ 12,32 x 6,02 m

⊕ 14,86 x 8,98 m

⌈ 7,83 m (mit Fahne)

⌋ 1,50 m 😊 5+



NORTHEIM

09.24.370 holz wood (o. Abb. no pic.)

09.24.371 Ferrum/Holz (wood)

09.24.372 Ferrum/HPL (o. Abb. no pic.)

⊕ 11,13 x 5,38 m ⊕ 14,55 x 8,07 m

⌈ 4,19 m ⌋ 1,75 m 😊 4+



SAARBRÜCKER KREISEL

09.08.088 Ferrum/HPL

⊕ 8,31 x 5,87 m ⊕ 10,70 x 9,62 m

⌈ 4,44 m ⌋ 2,25 m 😊 4+



WARBURG

09.24.320 holz wood

09.24.321 Ferrum/Holz wood

09.24.322 Ferrum/HPL o.ABB. no pic.

⊕ 8,46 x 4,00 m ⊕ 11,39 x 6,72 m

⌈ 4,49 m ⌋ 2,00 m 😊 4+



HEIKENDORF II

09.22.263 holz wood

o. Abb. no pic.

09.22.261 Ferrum/Holz wood

09.22.267 Ferrum/HPL

o. Abb. no pic.

⊕ 8,77 x 6,34 m ⊕ 11,77 x 9,31 m

⌈ 3,95 m ⌋ 1,50 m 😊 4+



REGENSBURG

09.24.725 Ferrum + holz wood

09.24.720 Holz wood o. Abb. no pic.

09.24.726 Ferrum/HPL o. Abb. no pic.

⊕ 7,33 x 6,36 m ⊕ 9,86 x 8,11 m

⌈ 4,20 m ⌋ 1,50 m 😊 4+



ERKELN

09.24.360 Holz wood o. Abb. no pic.

09.24.361 Ferrum/Holz wood o. Abb. no pic.

09.24.362 Ferrum/HPL

⊕ 6,44 x 6,09 m ⊕ 9,44 x 9,02 m ⌈ 4,15 m

⌋ 1,50 m 😊 4+



DIEMELAE

08.12.495

⊕ 10,66 x 7,64 m ⊕ 13,73 x 10,64 m
Ⓜ 4,46 m Ⓜ 2,00 m Ⓜ 1,50/2,00 m 😊 4+

BIRNBAUMS NAGEL

08.12.484

⊕ 6,98 x 6,54 x 4,46 m
⊕ 10,32 x 9,96 m
Ⓜ 4,46 m Ⓜ 2,00 m
😊 4+



DETFURTH

08.12.482

⊕ 4,80 x 4,91 m
⊕ Turm Ø 2,06 m
⊕ 8,50 x 7,90 m
Ⓜ 4,46 m
Ⓜ 2,00 m
😊 4+

QUARALUCA-CASTLE

08.12.492

⊕ 8,47 x 6,82 m ⊕ 11,96 x 9,82 m
Ⓜ 4,56 m Ⓜ 1,50 m 😊 4+

DESEMBERG

08.12.480

⊕ 2,09 x 1,87 m ⊕ 5,16 x 4,87 m
Ⓜ 3,96 m Ⓜ 1,50 m 😊 4+



RATHAUS PADERBORN

09.24.815

⊕ 4,21 x 4,13 m ⊕ 7,80 x 7,13 m

Ⓜ 4,11 m Ⓜ 1,75m

😊 4+



WINZICH

09.24.810 natur natural

09.24.811 farbig colour

⊕ 4,13 x 1,35 m ⊕ 7,30 x 4,54 m

Ⓜ 4,15 m Ⓜ 1,75 m 😊 4+



ECKHAUSEN

09.24.820 natur natural

09.24.821 farbig colour

⊕ 4,14 x 4,29 m ⊕ 7,31 x 7,78 m

Ⓜ 4,15 m Ⓜ 1,75 m 😊 4+



ACHTSAM

09.24.835

natur natural

09.24.836

farbig coloured

⊕ 7,39 x 7,11 m ⊕ 10,34 x 8,90 m

Ⓜ 4,40 m Ⓜ 2,00 m 😊 4+



**ACHTSAM
RÜCKANSICHT
BACKVIEW**



KUTTER-NEO I SHIP NEO I

04.11.280
 + 3,47 x 1,92
 + 6,47 x 4,92 m
 H 1,00 m F 2,35 m 3+



MAGELLAN

01.25.630
 + 19,94 x 3,76 m
 + 25,53 x 8,28 m
 H 5,50 m H 2,75 m 6+

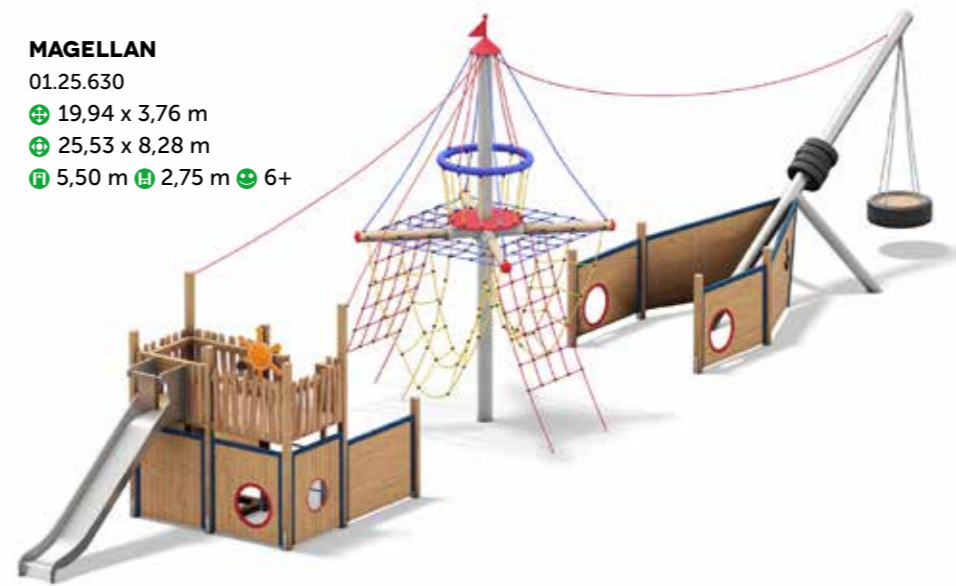

COLUMBUS

01.25.601
 + 20,88 x 6,83 m
 + 22,89 x 10,59 m
 F 8,01 m H 2,80 m 4+

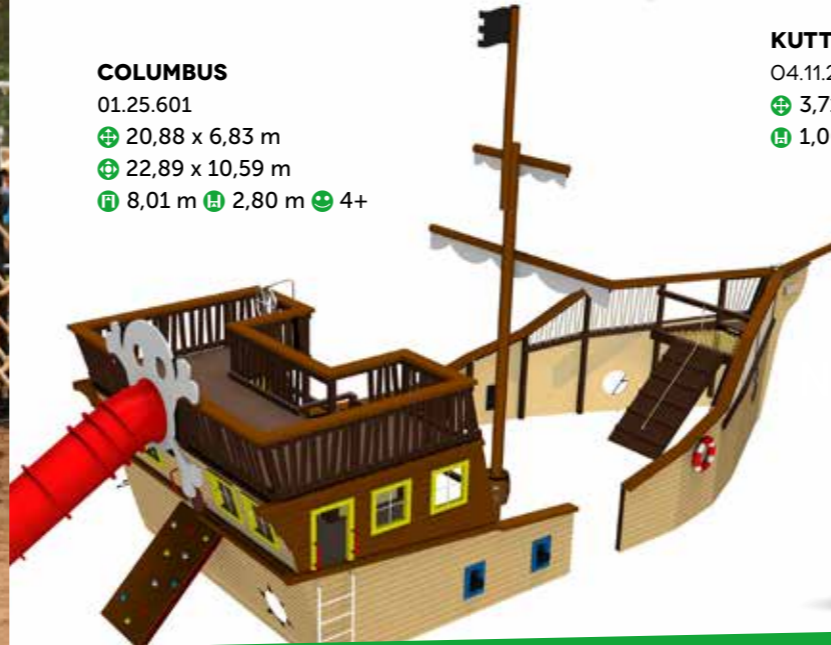

KUTTER-NEO II SHIP NEO II

04.11.282 MIT RUTSCHE WITH SLIDE
 + 3,71 x 3,47 m + 7,15 x 6,48 m
 H 1,00 m F 2,35 m 3+





MULTISPIELANLAGEN THEMENSPIELPLATZ

MULTIPLAY UNITS THEMED PLAYGROUND



ALMA

01.23.530

⊕ 8,36 x 4,61 x 4,30 m

⊕ 11,77 x 7,61 m

Ⓜ 4,29 m

Ⓜ 1,75 m

😊 4+



ELIOT

01.23.500

⊕ 6,20 x 4,58 m ⊕ 9,21 x 7,58 m

Ⓜ 3,26 m Ⓜ 1,75 m 😊 4+ #



EINHORN PROJEKT

UNICORN PROJECT

AUF ANFRAGE

ON DEMAND

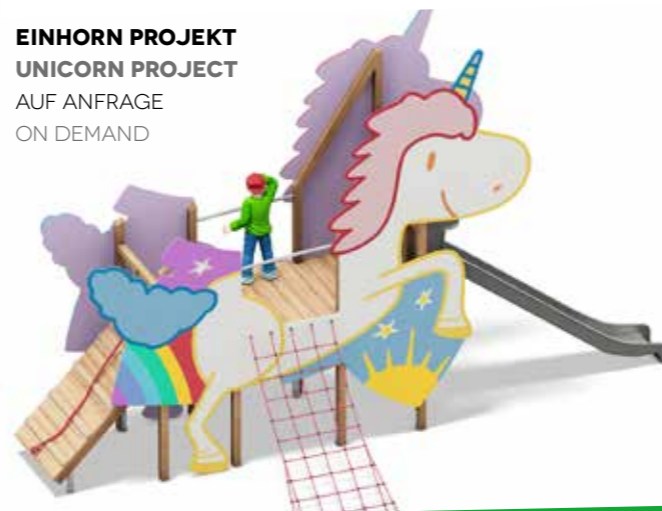

Aus Kundenwünschen erschaffen wir einzigartige Spielplatz-Attraktionen, die Kinderträume wahr werden lassen. Vom gutmütigen Drachen ELIOT bis zum Liebhaber-Projekt „Einhorn“, regen Themenspielflächen von PLAYPARC die kindliche Fantasie an und inspirieren jeden Tag zu immer neuen abenteuerlichen Spielideen.

We create unique playground attractions from customer wishes that make children's dreams come true. From the good-natured dragon ELIOT to the enthusiast project „Unicorn“, themed playgrounds from PLAYPARC stimulate children's imagination and inspire ever new adventurous play ideas every day.



FLOSSY

01.23.525

⊕ 7,40 x 4,75 m ⊕ 10,40 x 7,75 m Ⓜ 3,40 m Ⓜ 1,50 m 😊 4+



DRAKO

01.23.505

⊕ 6,20 x 4,58 m ⊕ 9,21 x 7,58 m Ⓜ 3,26 m Ⓜ 1,75 m 😊 4+





Das PANTHEON® ist eine Ikone auf jedem Spielplatz. Durch die vielfältigen Kletter- und Chill-Elemente werden Kinder zwischen 6 und 12 Jahren immer wieder auf's Neue inspiriert und herausgefordert.

The PANTHEON® is an icon on every playground. Due to the various climbing and chill elements, children between 6 and 12 years are inspired and challenged again and again.

Die großen Bögen bestehen aus 140 mm Stahlrohr. Die Netze werden ohne störende Schellen befestigt und ermöglichen so ein ganz besonderes Klettererlebnis.

The large arches are made of 140 mm steel tubing. The nets are attached without disturbing clamps and thus allow a very special climbing experience.



PANTHEON I
15.23.401
⊕ 10,76 x 7,77 m
⊕ 13,76 x 10,77 m
Ⓜ 3,94 m Ⓜ 2,99 m 😊 4+



HALLY GALLY SEILNETZ-SPIELGERÄTE

KLETTERN - BEWEGEN - ENTSPANNEN

HALLY GALLY NET PLAY UNITS

CLIMB - MOVE - RELAX



NEO-Netz

Alles Netz! Suchen Sie komplexe Raumnetze, Seil-Pyramiden, klassische Hally-Gally® Dreh-Wippen oder gigantische Netzanlagen? Hier werden Sie fündig.

NEO-Netz

Net crazy! Are you on the lookout for sophisticated space nets, rope pyramids or classical Hally-Gally® spinning seesaws and/or huge net systems? You've come to the right place.



HALLY-GALLY RAUMKAPSEL HALLY-GALLY SPACE CABIN

15.20.510 Wippbalken Leimbinder glued laminated timber

15.20.511 Wippbalken metall metal beams

⊕ Ø 3,50 m ⊕ Ø 11,00 m ⊕ 3,10 m ⊕ 2,00 m 😊 6+



HALLY-GALLY PENDELSITZKOMBINATION

HALLY-GALLY PENDULUM SEAT COMBINATION

15.20.530 Wippbalken Leimbinder glued laminated timber

15.20.531 Wippbalken metall metal beams

⊕ Ø 3,80 m ⊕ Ø 14,00 m ⊕ 3,10 m ⊕ 1,50 m 😊 6+



HALLY-GALLY KLETTER-RONDELL

HALLY-GALLY CLIMBING ROUND

15.20.540 Wippbalken Leimbinder

glued laminated timber

15.20.541 Wippbalken metall metal beams

⊕ Ø 3,50 m ⊕ Ø 11,00 m ⊕ 3,10 m

⊕ 2,00 m 😊 6+



HALLY-GALLY

DREH-WIPP-MICH-KARUSSELL

HALLY-GALLY SWINGING TWO BY TWO

15.20.960 metall verzinkt metal zincd

⊕ Ø 3,90 m ⊕ Ø 14,00 m ⊕ 3,30 m

⊕ 1,50 m 😊 6+



HALLY-GALLY KLETTERPYRAMIDE, GROSS

HALLY-GALLY CLIMBING PYRAMID, LARGE

15.20.600 Stahlmast steel pole

⊕ Ø 3,50 ⊕ Ø 11,00 ⊕ 4,50 m

⊕ 2,80 m 😊 6+



HALLY-GALLY SPIRAL-KREISEL

HALLY-GALLY SPIRAL SPINNING TOP

15.20.640 Stahlmast steel pole

⊕ Ø 1,90 ⊕ Ø 10,00 m

⊕ 2,00 m ⊕ 3,05 m 😊 4 +



HALLY-GALLY-KLETTERPYRAMIDE, KLEIN

HALLY-GALLY-CLIMBING PYRAMID, SMALL

15.20.610 Stahlmast steel pole

⊕ Ø 3,50 ⊕ Ø 10,00 m ⊕ 2,00 m

⊕ 2,80 m 😊 6 +



SEILNETZ-SPIELGERÄTE

TÄGLICH NEUE ABENTEUER

NET PLAY UNITS

DAILY NEW ADVENTURES



HALLY-GALLY KLETTER-WIRBEL, GROSS
HALLY-GALLY CLIMBING WHIRL, LARGE
 15.20.650 Stahlmast steel pole
 ⊕ Ø 3,50 m ⊕ Ø 11,00 m
 📏 4,00 m 📏 2,50 m 😊 6+



HALLY-GALLY-WICHTELWIND
HALLY-GALLY-WICHTELWIND
 15.20.040 Stahlmast steel pole
 ⊕ Ø 2,00 m ⊕ Ø 9,00m 📏 2,10 m
 📏 1,00 m 😊 3+



HALLY-GALLY-KLETTERWIRBEL, MIDI
HALLY-GALLY-CLIMBING WHIRL, MIDI
 15.20.955 Stahlmast steel pole
 ⊕ Ø 2,00 m ⊕ Ø 10,00 m 📏 2,95 m
 📏 1,70 m 😊 4+



HALLY-GALLY PILZ-KREISEL
HALLY-GALLY TOADSTOOL
 15.20.590 Stahlmast steel pole
 ⊕ Ø 2,00 m ⊕ Ø 8,00 m
 📏 1,20 m 📏 0,90 m 😊 3+



HALLY-GALLY VOGELNEST-KARUSSELL PICCOLO
HALLY-GALLY ROUNDABOUT BIRD'S NEST, PICCOLO



15.06.132 Stahlmast steel pole
 ⊕ Ø 1,20
 ⊕ Ø 7,30 m
 📏 1,75 m 📏 1,00 m
 😊 <3



HALLY-GALLY VOGELNEST-KARUSSELL, MINI
ROUNDABOUT BIRD'S NEST, MINI
 15.06.130 Stahlmast steel pole
 ⊕ Ø 1,40 m ⊕ Ø 8,00 m
 📏 2,10 m 📏 0,80 m 😊 3+



HALLY-GALLY MINI-KREISEL
HALLY-GALLY MINI ROTATING TOP
 15.06.131 Stahlmast steel pole
 ⊕ Ø 1,90 ⊕ Ø 7,00 m
 📏 1,25 m 📏 0,80 m 😊 <3

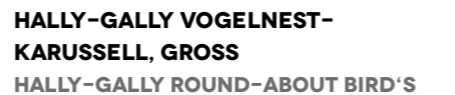

HALLY-GALLY VOGELNEST-KARUSSELL, GROSS
HALLY-GALLY ROUND-ABOUT BIRD'S



15.20.550 Stahlmast steel pole
 ⊕ Ø 1,90 x 3,80 m
 ⊕ Ø 9,00 m 📏 2,95 m
 📏 0,80 m 😊 3+



SEILNETZ-PYRAMIDE DINO I
ROPE NET PYRAMIDS DINO I
 15.01.100 Pyramide Dino I
 15.01.110 Ankerplatten-Set Anchor plate set
 ⊕ Ø 9,50 m ⊕ Ø 12,20 m 📏 6,00 m 📏 1,75 m 😊 6+



SEILNETZ-PYRAMIDE DINO III
ROPE NET PYRAMIDS DINO III
 15.03.100 Pyramide Dino III
 15.03.130 Ankerplatten-Set Anchor plate set
 ⊕ Ø 5,60 m ⊕ Ø 7,50 m 📏 3,20 m
 📏 1,50 m 😊 4+



SEILNETZ-PYRAMIDE DINO II
ROPE NET PYRAMIDS DINO II
 15.02.100 Pyramide Dino II
 15.02.120 Ankerplatten-Set Anchor plate set
 ⊕ Ø 8,00 m ⊕ Ø 10,00 m 📏 4,50 m
 📏 1,50 m 😊 4+



SEILNETZ-PYRAMIDEN

KINDER LIEBEN ES, GANZ WEIT OBEN ZU SEIN

NET PYRAMIDES

CHILDREN LOVE TO BE AT THE VERY TOP

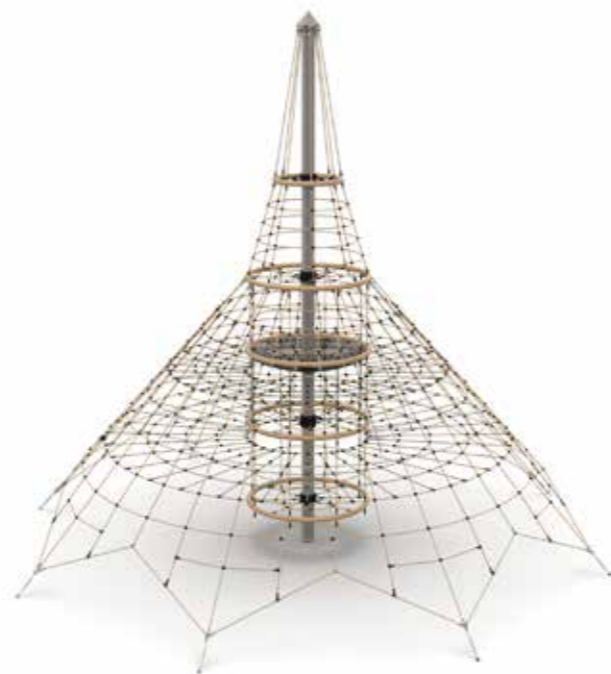

SEILNETZ-PYRAMIDE DINO XXL
 ROPE NET PYRAMIDS DINO XXL
 15.03.1XXX Pyramide Dino XXL
 ⚙️ Ø 9,55 m ⚙️ Ø 11,00 m 📏 8,20 m 📏 1,75 m 😊 4+

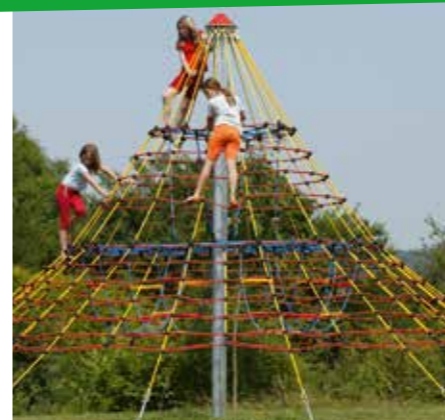

CHEOPS-PYRAMIDE MIDI
 CHEOPS MIDI
 15.06.002 Cheops-Pyramide MIDI
 15.06.102 Ankerplatten-Set Anchor plate set
 ⚙️ Ø 8,00 m ⚙️ Ø 11,00 m 📏 4,30 m 😊 6+



CHEOPS-PYRAMIDE MINI
 CHEOPS MINI
 15.06.001 Cheops-Pyramide MINI
 15.06.101 Ankerplatten-Set Anchor plate set
 ⚙️ Ø 4,00 m ⚙️ Ø 7,00 m 📏 3,50 m 😊 6+

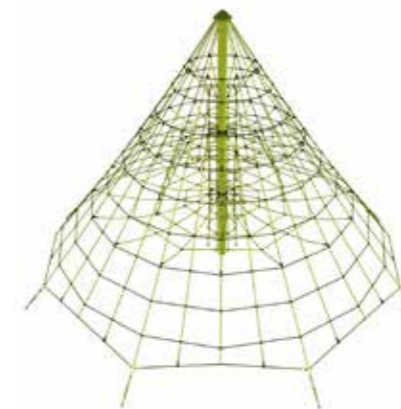

SEILNETZTURM I
 ROPE NET TOWER I
 15.04.100
 ⚙️ Ø 9,50 m ⚙️ Ø 11,60 m 📏 6,00 m 📏 2,00 m 😊 6+

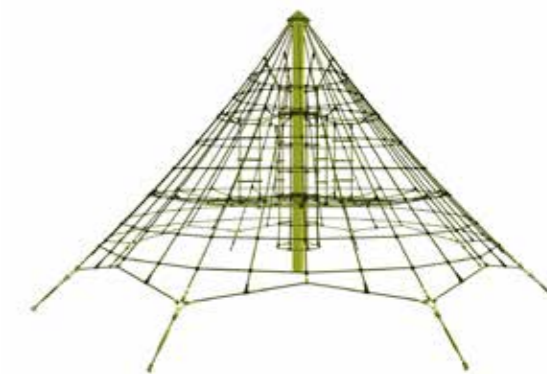

SEILNETZTURM II
 ROPE NET TOWER II
 15.04.200
 ⚙️ Ø 8,00 m ⚙️ Ø 10,00 m 📏 4,50 m 📏 1,50 m 😊 6+



CHEOPS-PYRAMIDE MAXI CHEOPS MAXI
 15.06.003 Cheops-Pyramide MAXI
 15.06.103 Ankerplatten-Set Anchor plate set
 ⚙️ Ø 11,00 m ⚙️ Ø 13,00 m 📏 5,60 m 😊 6+



TRIOPS-PYRAMIDE MINI
 TRIOPS PYRAMID MINI
 15.06.015
 ⚙️ 4,50 x 3,90 m ⚙️ 6,60 x 6,12 m 📏 3,15 m 📏 1,75 m 😊 4+





PIRATENTURM MINI PIRATE TOWER MINI

15.06.144
⊕ Ø 4,70 m ⊕ Ø 7,20 m ⊕ 3,85 m
⊕ 1,50 m 😊 3+

PIRATENSCHIFF STÖRTEBECKER MIT RUTSCHE

PIRATE SHIP „BLACK BEARD“ WITH SLIDE
15.06.223
⊕ 11,45 x 3,75 m ⊕ 15,15 x 7,20 m ⊕ 5,00 m
⊕ 2,75 m 😊 6 +



VOGELNESTBAUM

BIRD'S NEST TREE
15.06.117
⊕ Ø 8,00 m ⊕ Ø 11,00 m ⊕ 6,00 m
⊕ 2,80 m 😊 6 +

VOGELNESTBAUM MIDI

BIRD'S NEST TREE MIDI
15.06.118
⊕ Ø 4,00 m ⊕ Ø 7,50 m ⊕ 5,10 m
⊕ 2,00 m 😊 6 +

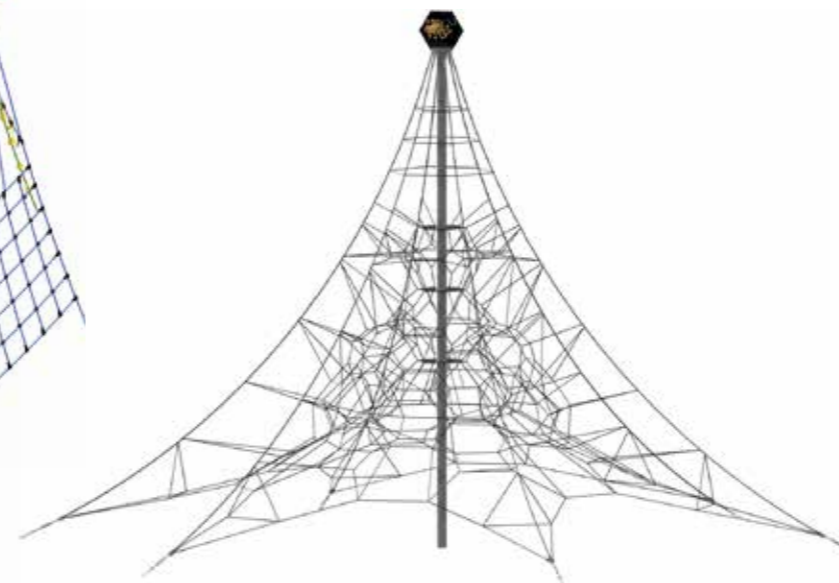

SEILPYRAMIDE SPIDER 8 MIT 6 ABSPANNUNGEN

ROPE PYRAMID SPIDER 8, 6 BRACINGS
15.06.007
⊕ 14,00 x 12,10 m
⊕ 15,00 x 13,50 m ⊕ 8,30 m
⊕ 1,80 m 😊 6 +

SEILPYRAMIDE SPIDER 4

MIT 4 ABSPANNUNGEN
ROPE PYRAMID SPIDER 4, 4 BRACINGS
15.06.006
⊕ 5,70 x 5,70 m ⊕ 7,80 x 7,80 m
⊕ 4,30 m ⊕ 0,85 m 😊 4+



SEILPYRAMIDE SPIDER 6

MIT 4 ABSPANNUNGEN
ROPE PYRAMID SPIDER 6, 4 BRACINGS
15.06.009
⊕ 8,75 x 8,75 m ⊕ 11,00 x 11,00 m
⊕ 6,20 m ⊕ 1,80 m 😊 4+



SEILPYRAMIDE SPIDER 6

MIT 6 ABSPANNUNGEN
ROPE PYRAMID SPIDER 6, 6 BRACINGS
15.06.008
⊕ 11,30 x 9,80 m ⊕ 14,60 x 13,00 m
⊕ 6,20 m ⊕ 1,60 m 😊 6 +

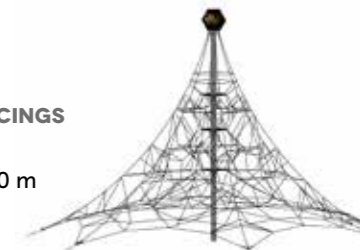



NETZWELTEN

EINE SPIELPLATZ-ATTRAKTION = 1001 ABENTEUER

NET WORLDS

ONE PLAY ATTRACTION = 1001 ADVENTURES



OLIVENBAUM

15.06.226

⊕ 7,40 x 6,60 x 6,85 m ⊕ 9,95 x 9,80 m

⊕ 3,00 m 😊 6+



ADLERHORST EHRINGSHAUSEN

LITTLE EAGLE'S NEST NESTING AREA

15.06.162

⊕ 4,65 x 4,10 m ⊕ 7,65 x 7,10 m

⊕ 2,20 m ⊕ 1,40 m 😊 ab 4 Jahre



VOGELNESTTURM FORTUNA

BIRD'S NEST TREE HOUSE

15.06.152

⊕ Ø 2,70 m ⊕ Ø 5,70 m ⊕ 2 m ⊕ 1 m

😊 3+



WICHELWALD RABENSCHIED

WITCH'S SLIDE & NET

15.06.156

⊕ 5,60 x 1,70 m ⊕ 8,70 x 4,70 m

⊕ 1,30 m ⊕ 1,00 m 😊 3 +



VOGELNESTBAUM ADLERHORST

EAGLE'S NEST TREE

15.06.119

⊕ Ø 4,30 m ⊕ 8,20 m ⊕ 5,75 m

⊕ 2,95 m 😊 6+



VOGELNESTBAUM MINI

BIRD'S NEST TREE MINI

15.06.151

⊕ 3,70 x 3,20 m ⊕ 6,10 x 5,75 m

⊕ 2,50 m ⊕ 0,70 m 😊 3 +

VOGELNESTTURM

BLACK FOREST

BIRD'S NEST TOWER „BLACK FOREST“

15.06.221

⊕ 7,85 x 5,65 m

⊕ 12,20 x 8,90 m

⊕ 6,65 m ⊕ 3,00 m

😊 6+



6-ECK-KLETTERBURG MAXI

MAXI HEXAGON CLIMBING CASTLE

15.06.234

⊕ 6,10 x 3,45 m ⊕ 9,10 x 7,20 m

⊕ 2,30 m 😊 4+

VOGELNESTTURM

BIRD'S NEST TOWER

15.06.220

⊕ 7,40 x 6,60 m

⊕ 9,95 x 9,80 m

⊕ 6,85 m ⊕ 3,00 m

😊 6+





SANDUHR ATTIGHOF
HOURGLASS
15.06.225
⊕ Ø 3,00 m ⊕ Ø 7,00 m
Ⓜ 5,30 m Ⓜ 3 m 😊 6 +



PIRATENTURM
STÖRTEBECKER
PIRATES TOWER
15.06.222
⊕ 3,75 x 2,45 m ⊕ 7,20 x 7,05 m
Ⓜ 5,30 m Ⓜ 2,75 m 😊 6 +



KLETTER-WIGWAM MIDI
MIDI CLIMBING TEEPEE
15.06.235
⊕ 3,35 x 3,35 m
⊕ 5,90 x 5,90 m Ⓜ 3,60 m
Ⓜ 2,15 m 😊 4 +

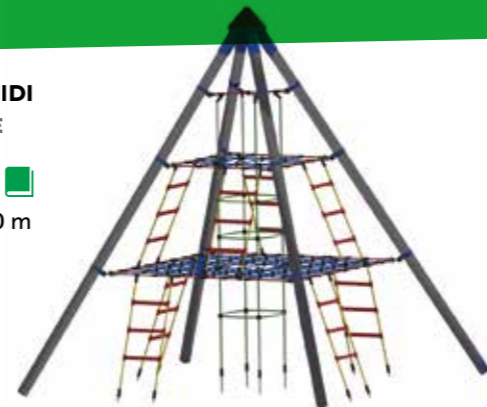

MINI SANDUHR
DIABOLO
15.06.237
⊕ Ø 1,90 m ⊕ 7,00 m
Ⓜ 2,90 m Ⓜ 2,00 m
😊 4 +

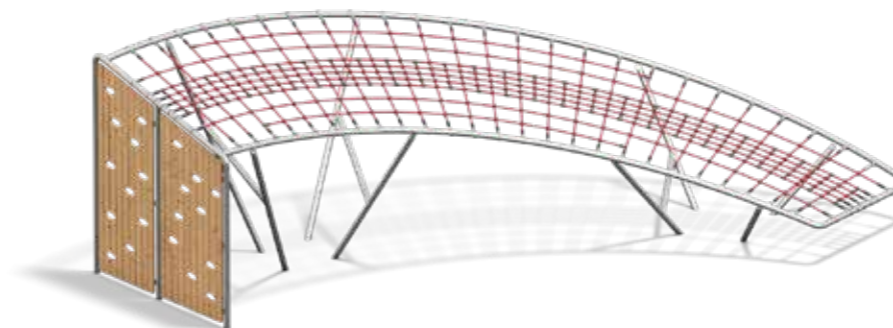

KOMETENSCHWEIF SCHULE
COMET TAIL „SCHOOL“

15.22.605
⊕ 8,05 x 3,38 m ⊕ 12,36 x 7,40 m Ⓜ 2,50 m
Ⓜ 2,50 m 😊 6 +

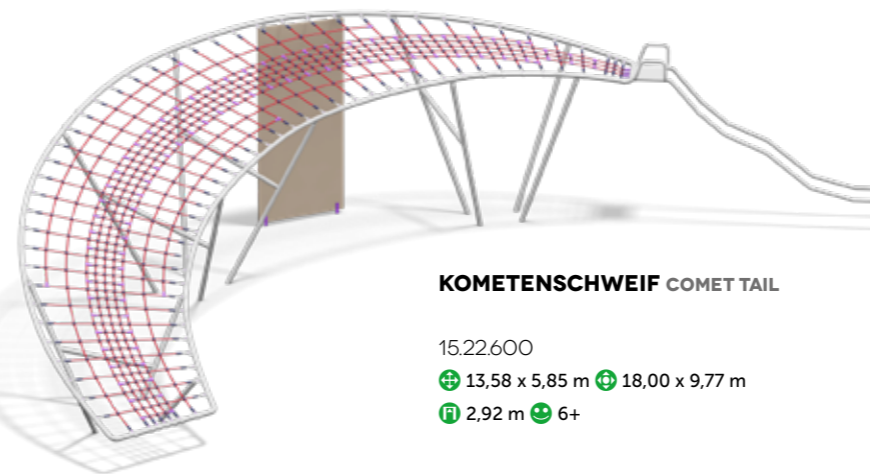

KOMETENSCHWEIF COMET TAIL

15.22.600
⊕ 13,58 x 5,85 m ⊕ 18,00 x 9,77 m
Ⓜ 2,92 m 😊 6 +



FORTUNA PARCOURS
FORTUNA PLAY COURSE
15.06.145
⊕ 3,80 x 3,45 m
⊕ 6,80 x 6,45 m Ⓜ 2,00 m
Ⓜ 1,00 m 😊 3 +





SERPENTES® ACHTERBAHN SERPENTES® ROLLER COASTER

15.23.100 MODUL GERADE MODULE STRAIGHT



15.23.120 MODUL 45° INNEN GENEIGT
MODULE INCLINED 45° INWARDS



15.23.130 MODUL 45° AUSSEN GENEIGT
MODULE INCLINED 45° OUTWARDS



15.23.140 MODUL 90° INNEN GENEIGT
MODULE INCLINED 90° INWARDS



15.23.150 MODUL 90° AUSSEN GENEIGT
MODULE INCLINED 90° OUTWARDS

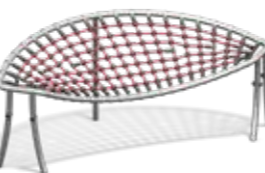

MÖGLICHKEIT ZUR FREIEN PLANUNG

SERPENTES®-Spielanlagen sind modular-kombinierbar. Das bietet Ihnen eine flexible und kreative Gestaltung in der Planung. So passt sich das Spielkonzept den Platzverhältnissen an. Hier bestimmen Sie, wie Ihre Spieleinheit aussieht.

POSSIBILITY FOR FREE PLANNING

SERPENTES® play systems are modularly-combinable. This offers a flexible and creative design in the planning. Thus, the game concept adapts to the space available. Here you determine the look of your play equipment.



KLETTERN, CHILLEN, BALANCIEREN, RUTSCHEN, KOMMUNIZIEREN, INTERAGIEREN UND GESTALTEN

Kinder brauchen einen Platz, der ihre Sinne inspiriert und der sie zum fantasievollen, freien und spontanen Spiel anregt. Nach diesem Grundsatz wurde das flexible Modulsystem SERPENTES® entwickelt. SERPENTES® ist eine nach physiologischen Grundlagen entwickelte Kletteranlage, die die Grobmotorik, den Gleichgewichtssinn und die Muskulatur fördert und viel Freiraum zum Spielen und Chillen bietet.

MODUL A MODULE A 15.23.030

MODUL B MODULE B 15.23.040

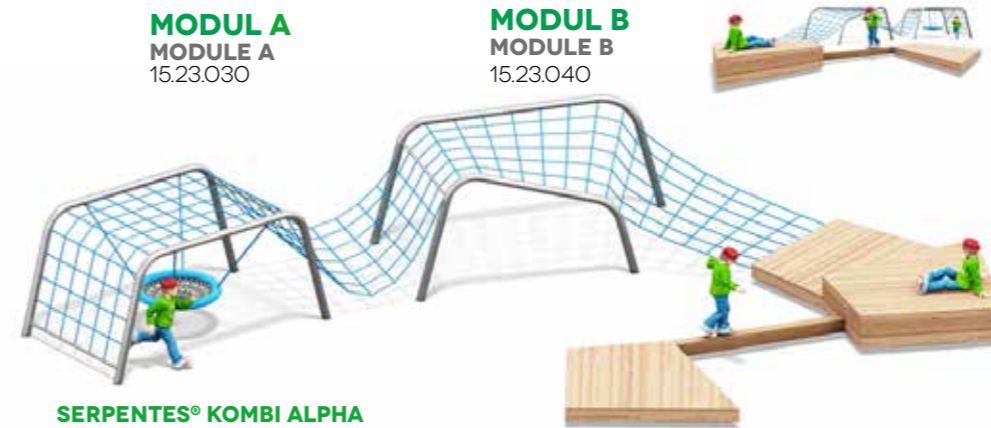

SERPENTES® KOMBI ALPHA

15.23.001

CLIMBING, RELAXING, BALANCING, SLIDING, COMMUNICATING, INTERACTING AND DESIGNING

Children need a place that inspires their senses and encourages them to play imaginative, free and spontaneous games. The flexible SERPENTES® modular system was developed according to this principle. SERPENTES® is a climbing equipment developed on the basis of physiological principles that promotes gross motor skills, the sense of balancing and the musculature and offers plenty of space for playing and chilling.

MODUL C MODULE C 15.23.310





MODUL D TRIBÜNE
MODULE D STAGE
15.23.303

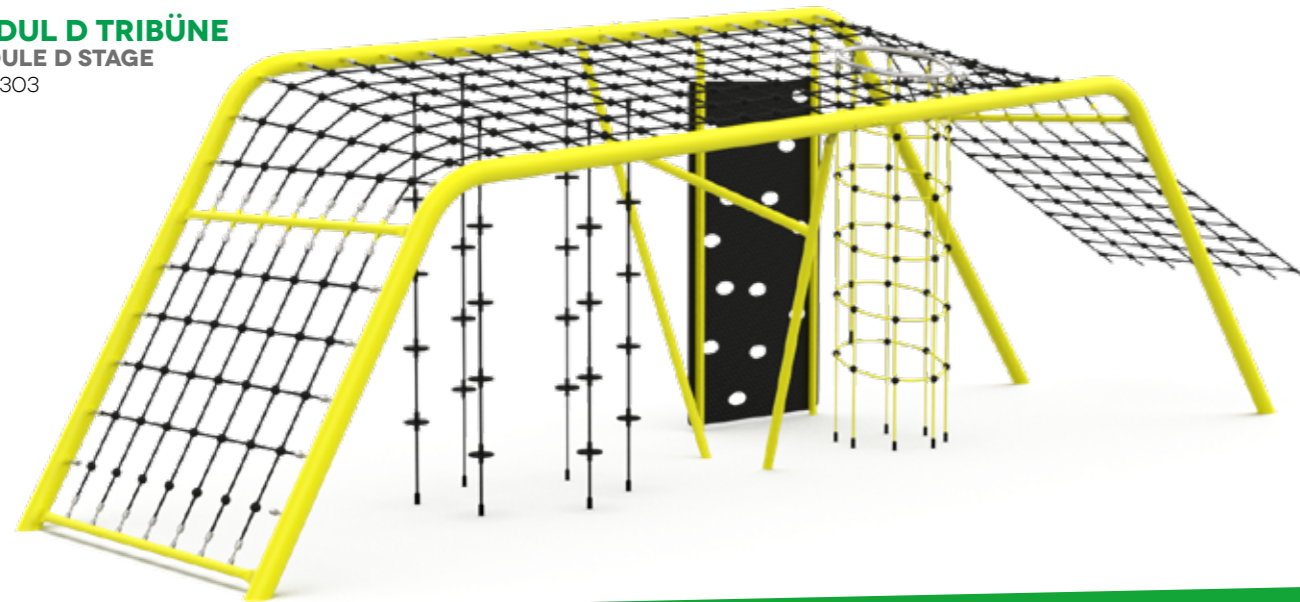

MODUL A
MODULE A



15.23.301

MODUL E
MODULE E



15.23.305

MODUL B
MODULE B

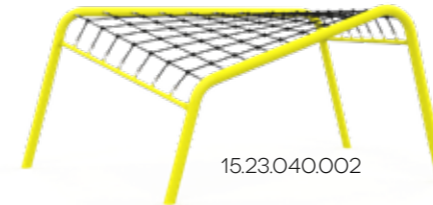

15.23.040.002



15.23.306

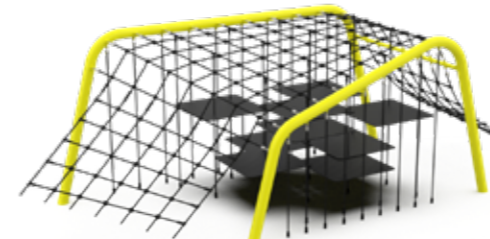

15.23.302



15.23.307

Alle Module sind neben der Basis-Version aus Edelstahl auch zusätzlich pulverbeschichtet (RAL-Farben) erhältlich.



Sonderfarben auf Anfrage / special colors on request

All modules are optionally available with powder-coated steel (RAL colors) in addition to the basic stainless steel version.





TRAMPOLINE FÜR MEHR FREUDE

Trampoline sind eine tolle Lösung für alle, die sich mit viel Freude bewegen möchten. Beim Trampolinspringen wird der gesamte Körper auf eine gesunde Weise trainiert, weil die Gelenke dabei kaum belastet werden.

TRAMPOLINES FOR MORE FUN

Trampolines are a great solution for those who want to move with a lot of pleasure. Trampolining is a healthy way to exercise the whole body, because there is hardly any stress on the joints.



TRAMPOLIN 2000

15.21.710

- ⊕ 3,00 x 2,25 m
(Sprungfläche 2,50 x 1,75 m)
(jumping area 2.50 x 1.75 m)
- ⊕ 6,50 x 5,75 m



TRAMPOLIN 2014

15.21.725

- ⊕ 2,25 x 2,25 m
(Sprungfläche 1,60 x 1,60 m)
(jumping area 1.60 x 1.60 m)
- ⊕ 5,60 x 5,60 m

15.21.720 mit Eingrabrahmen
with frame

15.21.721 ohne Eingrabrahmen
with frame



EINGRABRAHMEN FÜR ERDEINBAU

Stahlblechrahmen entsprechend den Maßen der Einbautrampoline für eine Montage ohne Betonarbeiten. Ideal, um die Montage des Gerätes in einem Zug durchführen zu können.

FRAME FOR GROUND INSTALLATION

Sheet steel frame according to the measurements of the built in trampolines for installation without concrete works. Ideal to carry out the installation of the item in one step.



TRAMPOLIN XXL

15.21.735

- ⊕ 7,00 m x 5,75 m
(Sprungfläche 3,00 x 1,75 m)
(jumping area 3.00 x 1.75 m)
- ⊕ 5,75 x 7,00 m



TRAMPOLIN CIRCUS, RUND ROUND

15.21.615

- ⊕ Ø 1,90 m (Sprungfläche Ø 1,30 m)
- ⊕ Ø 4,35 m (jumping area Ø 1.30 m)

TRAMPOLIN CIRCUS MAXIMUS, RUND ROUND

15.21.619

- ⊕ Ø 2,50 m (Sprungfläche Ø 1,90 m)
- ⊕ Ø 5,90 m (jumping area Ø 1,90 m)

MAXIMUS

65.01.040

- ⊕ 6,00 x 1,65 m
(Sprungfläche 5,34 x 0,98 m)
(jumping area 5.34 x 0.98 m)
- ⊕ 9,35 x 4,99 m



Die Anlaufkanten für Rollstuhlfahrer können gegen Aufpreis abgeschrägt geliefert werden.
The leading edges for wheelchair users can be supplied bevelled for an extra charge.



MINI TRAMPOLIN

15.21.610

- ⊕ 1,75 x 1,75 m
(Sprungfläche 1,25 x 1,25 m)
(jumping area 1.25 x 1.25 m)
- ⊕ 5,25 x 5,25 m





TRAMPOLINE

BEWEGUNG - SPASS - TRAINING - SPIEL



TRAMPOLIN SATURNUS, OVAL

15.21.617
 Ⓡ Ø 2,50 x 1,50 x 0,35 m
 (Sprungfläche Ø 2,00 x 1,00 m) (jumping area Ø 2,00 x 1,00 m)
 Ⓡ 5,00 x 4,00 m



TRAMPOLIN TRIANGULUM

15.21.618.
 Ⓡ 3,60 x 3,60 m
 (Sprungfläche 2,13 x 2,13 m)
 (jumping area 2,13 x 2,13 m)
 Ⓡ 6,50 x 6,50 m



TRAMPOLIN 2012

NEONGRÜN GREEN
 15.21.716
 Ⓡ 2,50 x 2,00 m
 (Sprungfläche 1,85 x 1,35 m)
 (jumping area 1,85 x 1,35 m)
 Ⓡ 5,85 x 5,35 m



TRAMPOLIN 2012

15.21.715
 Ⓡ 2,50 x 2,00 m
 (Sprungfläche 1,85 x 1,35 m)
 (jumping area 1,85 x 1,35 m)
 Ⓡ 5,85 x 5,35 m



TRAMPOLIN PICCOLO

15.21.614
 Ⓡ 1,25 x 1,25 m
 (Sprungfläche 0,75 x 0,75 m)
 (jumping area 0,75 x 0,75 m)
 Ⓡ 3,75 x 3,75 m



TRAMPOLIN ROLLI

15.21.730
 Ⓡ 3,00 x 1,40 m
 (Sprungfläche 2,50 x 0,90 m)
 (jumping area 2,50 x 0,90 m)
 Ⓡ 6,50 x 4,90 m

TRAMPOLINES

MOVEMENT - FUN - TRAINING - PLAY



ABSCHRÄGUNG:

Type A = abgeschrägte Platten
 1 Schmalseite (für Rolli-Fahrer)

Type B = Rampe innenliegend
 1 Schmalseite (für Rolli-Fahrer)

a = Mit Sicherheitssprungtuch
 b = Sprungtuch nicht abnehmbar

BEVEL:

Type A = bevelled panels
 1 narrow side (for wheelchair)

Type B = Ramp on the inside
 1 narrow side (for wheelchair)

a = with security jumping mat
 b = jumping mat not removable

TYP A TYPE A

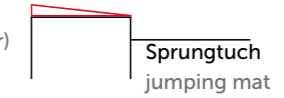

TYP B TYPE B



REINIGUNGSMODUS:

H = Heben (Rahmen abnehmbar)
 K = Klappen (Rahmen aufklappbar)
 A = Aushängen (Sprungtuch)
 Mit Sondereingrabrahmen: H=K

CLEANING MODE:

H = Lift (Frame can be lifted)
 K = Open (Frame can be opened)
 A = Unhook (jumping mat)
 special frame ground installation: L=O

TYP TYPE	ARTIKEL ITEM	NAME	SPRUNG-FLÄCHE JUMPING AREA	ABMESSUNGEN DIMENSIONS	EINGRAB-RAHMEN FRAME GROUND INSTALLATION	SONDER EINGRABRAHMEN CONTINUOUS SURFACING FRAME	REINIGUNGSMODUS CLEANING MODE
RUND ROUND	15.21.617	SATURNUS (OVAL)	1,00 X 2,00 M	1,50 X 2,50 M	X	X	H
	15.21.615	CIRCUS (RUND / ROUND)	1,30 M Ø	1,90 M Ø	X	X	H
	15.21.619	CIRCUS MAXIMUS (RUND / ROUND)	1,90 M Ø	2,50 M Ø	X	X	H
ECKIG SQUARE	15.21.720	TRAMPOLIN „2000“ a, b	1,75 X 2,50 M	2,25 X 3,00 M	X		-
	15.21.710	TRAMPOLIN „2000“ a	1,75 X 2,50 M	2,25 X 3,00 M			K
	15.21.715	TRAMPOLIN „2012“	1,35 X 1,85 M	2,00 X 2,50 M	X		A
	15.21.716	TRAMPOLIN „2012“ NEONGRÜN GREEN	1,35 X 1,85 M	2,00 X 2,50 M	X	X	A
	15.21.725	TRAMPOLIN „2014“ BAUSATZ KIT	1,60 X 1,60 M	2,25 X 2,25 M	X	X	A
	65.01.040	MAXIMUS VI, 6 M (OPTIONAL 9 M)	0,98 X 5,34 M	1,64 X 6,00 M	X	X	A
	15.21.614	TRAMPOLIN „PICCOLO“ F. RASENFLÄCHE a FOR GRASS a	0,75 X 0,75 M	1,25 X 1,25 M	X		H
	15.21.610	MINI-TRAMPOLIN ZUM EINBAU a FOR BUILDING IN a	1,25 X 1,25 M	1,75 X 1,75 M	X		K
	15.21.730	TRAMPOLIN „ROLLI“ a „WHEEL-CHAIR“ a	0,90 X 2,50 M	1,40 X 3,00 M			K
	15.21.618	TRAMPOLIN „TRIANGULUM“ DREIECKIG TRIANGULAR	2,13 X 2,13 M	3,00 X 3,00 M	X		H
15.21.735	TRAMPOLIN XXL a		1,75 X 3,00 M	2,25 X 3,50 M			K



MULTIFUNKTIONALE ARENEN

DAS VARIABLE BALLSPORT-SPIELFELD



Alle Multisportanlagen von PLAYPARC werden unter Berücksichtigung aller gültigen Sicherheitskriterien gestaltet, entwickelt und gefertigt. Sorgloses Spielen ist damit garantiert. Und selbstverständlich entspricht die Anlage - wie alle unsere Projekte - auch den geltenden Normen.

Zum Einsatz kommen umweltfreundliche Materialien, die auch das Kriterium der Dauerhaftigkeit und Nachhaltigkeit erfüllen.

Es gibt unterschiedliche Standardgrößen, und die grundlegende Möglichkeit eine Multisportanlage mit oder ohne Kunstrasen-Spielteppich zu planen. Die Linien im Teppich sind eingelegt und somit besonders dauerhaft.

Die Brüstungen haben einen Abschluss aus einem Aluminium-Sitzprofil, auf dem alle Zuschauer sitzen können - ein echter Treffpunkt!

All PLAYPARC Multi Use Game Arenas are designed, developed and manufactured in accordance with all applicable safety criteria. Carefree playing is thus guaranteed. And of course, the plant - like all our projects - also complies with the applicable standards. Environmentally friendly materials are used which also meet the criteria of durability and sustainability.

There are different standard sizes, and the basic possibility to plan a multi-sport facility with or without artificial turf play carpet. The lines in the carpet are inlaid and therefore particularly durable.

The balustrades are finished with an aluminium seat profile on which all spectators can sit - a real meeting point!

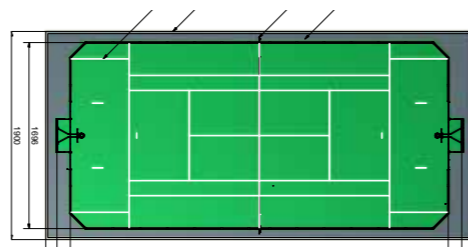

MULTI USE GAME ARENAS

THE VARIABLE BALL SPORTS ARENA



INDIVIDUELLE ANLAGEN-KONZEPTE

Gerne erstellen wir Ihr ganz individuelles Multi-Sportanlagenkonzept. Jeder Standort hat seine eigenen Herausforderungen und Zielsetzungen und wir wollen Ihnen helfen eine nachhaltige Nutzung zu erreichen. Auch die Ausstattung wird gemäß Ihren Wünschen und auf Basis aller bestehenden Konzepte, Module und Optionen erstellt.

INDIVIDUAL SYSTEM CONCEPTS

We would be pleased to create your individual multisport facility concept. Each location has its own challenges and objectives and we want to help you achieve sustainable use. Also the equipment will be provided according to your wishes and on the basis of all existing concepts, options and extras.

- A** 45° abgeschrägte Ecken, zusätzliche seitliche Tore möglich
45° bevelled corners, additional side doors possible
- B** Basketballkorb höhenverstellbar, Eingang durch Tor, Tor mit Netz
Basketball basket height adjustable, entrance through goal, goal with net
- C** hochwertiger Kunstrasen-Spielteppich, mit eingeleigten Linien für hohe Lebensdauer
high-quality artificial turf play carpet, with inlaid lines for a long service life
- D** Zusätzliche Basketballkörbe ausserhalb sind möglich
Additional basketball baskets outside are possible
- E** Bande als Sitzfläche, perfekter Treffpunkt
Surface of balustrades as seat, perfect meeting point



BALLFANGNETZ FÜR ALLE SEITEN ERHÄLTlich
BALL CATCHER NET FOR ALL SIDES AVAILABLE

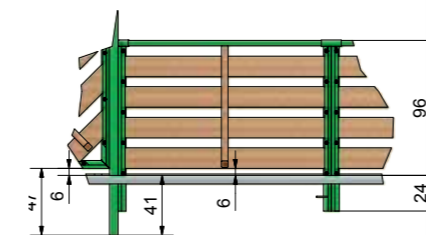
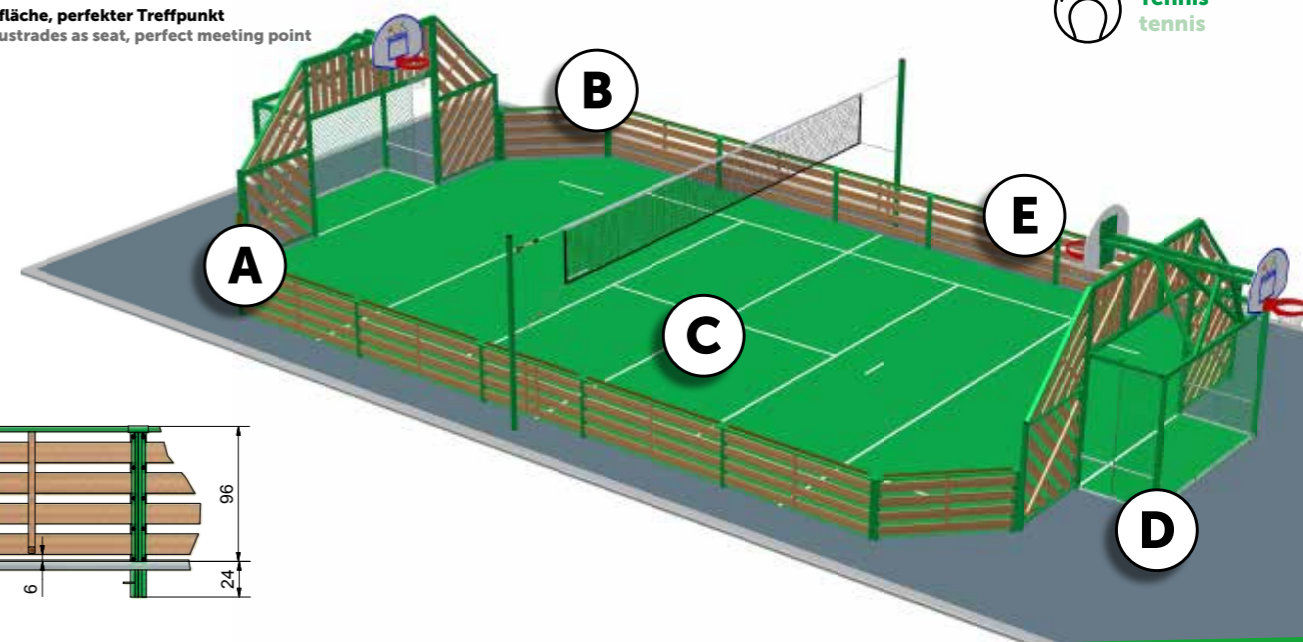

Fußball
Football



Volleyball
volleyball



Basketball
basketball



Badminton
badminton



Handball
handball



Hockey
hockey



Tennis
tennis



MULTIFUNKTIONALE ARENEN

MULTI USE GAME ARENAS

SPORTGERÄTE

SPORTS EQUIPMENT



Materialkombinationen

3 unterschiedliche Materialkombinationen sind bei unseren Multisportanlagen möglich. Je nach Budget und Einsatzzweck haben Sie hier die Wahl. Lassen sie sich von uns beraten, welche Kombination die richtige für Sie ist.

Material combinations

3 different combinations of material are possible with our multisport facilities, depending on the budget and usage you have the choice.

Standardgrößen standard sizes

BEZEICHNUNG DESIGNATION	AUSSENABMESSUNG EXTERIOR DIMENSIONS	LINIE MB ² (OHNE KUNSTRASEN) LINE MB ² (WITHOUT ARTIFICIAL TURF)	LINIE ALU-WOOD (OHNE KUNSTRASEN) LINE ALU-WOOD (WITHOUT ARTIFICIAL TURF)	LINIE TM (OHNE KUNSTRASEN) LINE TM (WITHOUT ARTIFICIAL TURF)
MULTISPORT-XS (200)	19.70 X 9.76 M	12.02.061 (12.02.022)	12.02.075 (12.02.036)	12.02.049 (12.02.008)
MULTISPORT S (250)	22.02 X 12.12 M	12.02.071 (12.02.023)	12.02.076 (12.02.037)	12.02.050 (12.02.009)
MULTISPORT M (300)	24.66 X 12.12 M	12.02.070 (12.02.024)	12.02.077 (12.02.038)	12.02.051 (12.02.010)
MULTISPORT L (450)	29,62 X 15,16 M	12.02.068 (12.02.025)	12.02.078 (12.02.039)	12.02.052 (12.02.011)
MULTISPORT XL (650)	36,90 X 17,12 M	12.02.069 (12.02.026)	12.02.079 (12.02.040)	12.02.053 (12.02.012)

TRIPLEX-SYSTEM

Oberflächenbehandlung des Metalls einschließlich Vorverzinkung + Kataphorese (Elektrolysebad) + Thermolackierung mit duroplastischer Pulverbeschichtung. Antikorrosionsbehandlung und perfekte Oberflächenbearbeitung.

TRIPLEX-SYSTEM

Treatment of the metal surface, including zinked and thermolacking with a duroplastic powder coating. Anti-corrosion treatment and perfect surface finish.



Linie MB²

Metall & Holzbrüstungen
Metal & wooden barriers



Linie ALU-WOOD

Aluminium & Holzbrüstungen
Aluminium & wooden barriers



Linie TM

Komplett Metall
Total metal



FUSSBALLTOR, 3 X 2 M

SOCCER GOAL, 3 X 2 M

12.01.050 FUßBALLTOR, ALUMINIUM ALUMINUM

⊕ 3,16 x 2,08 m

Passendes Tornetz Matching net

16.04.280 TORNETZ, NYLON, GRÜN GOAL



MINI-BOLZPLATZTOR

GOAL COMPLETE METAL, MINI

12.01.054

Innen: 120 x 80 x 65 cm, Aluminium vollverschweißt

Inside: 120 x 80 x 65 cm, aluminum fully welded

⊕ 1,43 x 0,73 x 0,80 m



BOLZPLATZTOR, 3 X 2 M

GOAL COMPLETE METAL, 3 X 2 M

12.01.038

⊕ 3,13 x 0,73 m 🏠 2,00 m



KICKWAND, HOLZ

SOCCER WALL, WOOD

12.01.030

⊕ 2,70 x 0,17 m 🏠 1,71 m 😊 4+

Preise auf Anfrage Price on request
Artikelnummern in Klammern bezeichnen die Anlagen OHNE Kunstrasen im Lieferumfang.
Article numbers in parentheses indicate the systems WITHOUT artificial turf in the scope of delivery.





TT-TISCH, ACRYLBETON

Spielfläche aus wetterfestem Acrylbeton. Grün Standardfarbe (auf Wunsch auch in blau lieferbar). Unterkonstruktion aus verzinktem Stahl oder aus armiertem Polymerbeton. Netz aus 4 mm starken Alu-Lochblech.

TABLE TENNIS TABLE, ACRYLIC CONCRETE

Playing surface made of weatherproof acrylic concrete. Green standard color (also available in blue on request). Substructures made of zinc plated steel or of reinforced polymer concrete. Net of aluminum perforated plate, 4 mm thick.

13.03.076 BETON-UNTERGESTELL WITH CONCRETE BASE

13.03.075 METALL-UNTERGESTELL METAL BASE

⊕ 2,75 x 1,54 m ♿ 240 kg 😊 6+

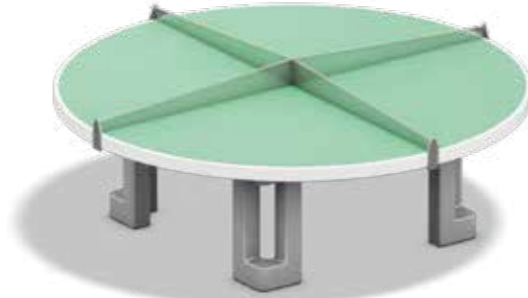

TT-Tisch Rund, Acrylbeton

Der runde Tischtennis-Tisch ist aus witterungsbeständigem Acrylbeton. Das Netz besteht aus verzinktem Stahl.

TT-Table Round, acrylic concrete

The round table tennis table is made of weather proof acrylic concrete.

13.02.055

⊕ Ø 2,40 x 0,65 m ♿ ca. 415 kg 😊 6+



TT-Tisch,

Park Volltreffer, inkl. Anker Set der TT-Tisch ist aus Stahl verzinkt mit umlaufendem Kantschutz und einer 9 mm Melaminplatte. **10 Jahre Garantie.**

Table tennis table, Park „volltreffer“, incl. Anchor Set TT table is zinc plated steel, protection with circumferential edge and a 9 mm melamine board. **10 year warranty.**

13.03.072 METALL-UNTERGESTELL METAL BASE

⊕ 2,74 x 1,52 m ♿ 0,76 m ♿ 245 kg 😊 6+



BASKETBALLSTÄNDER

BASKETBALL RACKS

12.03.120

⊕ 2,43 x 1,08 m

♿ 3,67 m

😊 ab 4 Jahr

BEACH-VOLLEYBALL-TURNIERNETZ, POLYESTER

BEACH-VOLLEYBALL-VOLLEYBALLNET, POLYESTER

12.01.063

PFOSTEN, VERZINKT, Ø 83 MM

POSTS, ZINCED, Ø 83 MM

12.01.061

BODENHÜLSE FÜR VOLLEYBALL-PFOSTEN

GROUND SLEEVE FOR VOLLEYBALL-POSTS

12.01.062





SPIELPLATZ-MOBILIAR

HINSETZEN - AUSRUHEN - BRETTSPIELE

PLAYGROUND FURNITURE

SIT - REST - BOARD GAMES



ELMAS KLEINKINDERBANK
ELMAS TODDLERS BENCH
30.06.091
⊕ 0,89 x 0,45 m ⊞ 0,59 m 😊 2+



SCHLENDRIAN
14.15.000
⊕ 1,95 x 0,73 x 0,65 m ⊞ 0,72 m



ELMOS KLEINKINDERTISCH
ELMOS TODDLERS TABLE
30.06.092
⊕ 0,89 x 0,59 m ⊞ 0,48 m 😊 2+



ELMIS KLEINKINDERBANK
ELMIS TODDLERS BENCH
30.06.093
⊕ 0,90 x 0,45 x 0,26 m ⊞ 0,26 m 😊 2+



SITZ- UND AUFBEWAHRUNGSBANK
BENCH FOR SITTING AND STORAGE
13.02.050
⊕ 2,10 x 0,60 m ⊞ 1,30 m ⊞ 0,45 m



SCHACH & DAME SPIELTISCH
CHESS & CHECKER GAME TABLE
14.14.460
⊕ 0,75 x 0,75 x 0,74 m
Spieltische ohne Abb / tables without pic
MÜHLE SPIELTISCH / MILL GAME TABLE
14.14.462
LUDO SPIELTISCH / LUDO GAME TABLE
14.14.466



HEIDELORE
14.02.110
⊕ 2,00 x 1,54
⊞ 0,70 m



JUGENDBANK
TEEN BENCH
14.01.010
⊕ 1,64 x 0,58 m
⊞ 0,85 m



RELAXING
14.02.150
⊕ 1,48 x 1,60
⊞ 1,14 m



HEIDI
14.02.113
⊕ 2,00 x 1,51
⊞ 0,7 m



SITZHOCKER MIT LEHNE
SEAT STOOL WITH BACKREST
14.14.470
⊕ 0,60 x 0,40 ⊞ 0,75 m

SITZHOCKER OHNE LEHNE
(ohne Abbildung)
SEAT STOOL WITHOUT BACKREST
14.14.472 (without pict.)
⊕ 0,40 x 0,40 ⊞ 0,45 m



SITZGRUPPE WARBURG
SEATING ARRANGEMENT WARBURG
14.02.125 SITZGRUPPE MIT TISCH UND BANK SEATING WITH TABLE AND BENCH
⊕ 3,52 x 3,11 ⊞ 0,85 m

14.02.126 MIT 3 HOCKERN WITH 3 STOOLS
⊕ 3,52 x 3,11 ⊞ 0,85 m
14.02.127 SITZHOCKER EINZELN SINGLE STOOL
⊕ 0,40 x 0,40 ⊞ 0,45 m



GABI
14.02.120
⊕ 2,00 x 1,31 x 0,73 m ⊞ 0,72 m
14.02.123
⊕ 3,00 x 1,31 x 0,73 m ⊞ 0,72 m

GABI INKLUSION
14.02.113
⊕ 2,50 x 1,31 x 0,83 m ⊞ 0,83 m





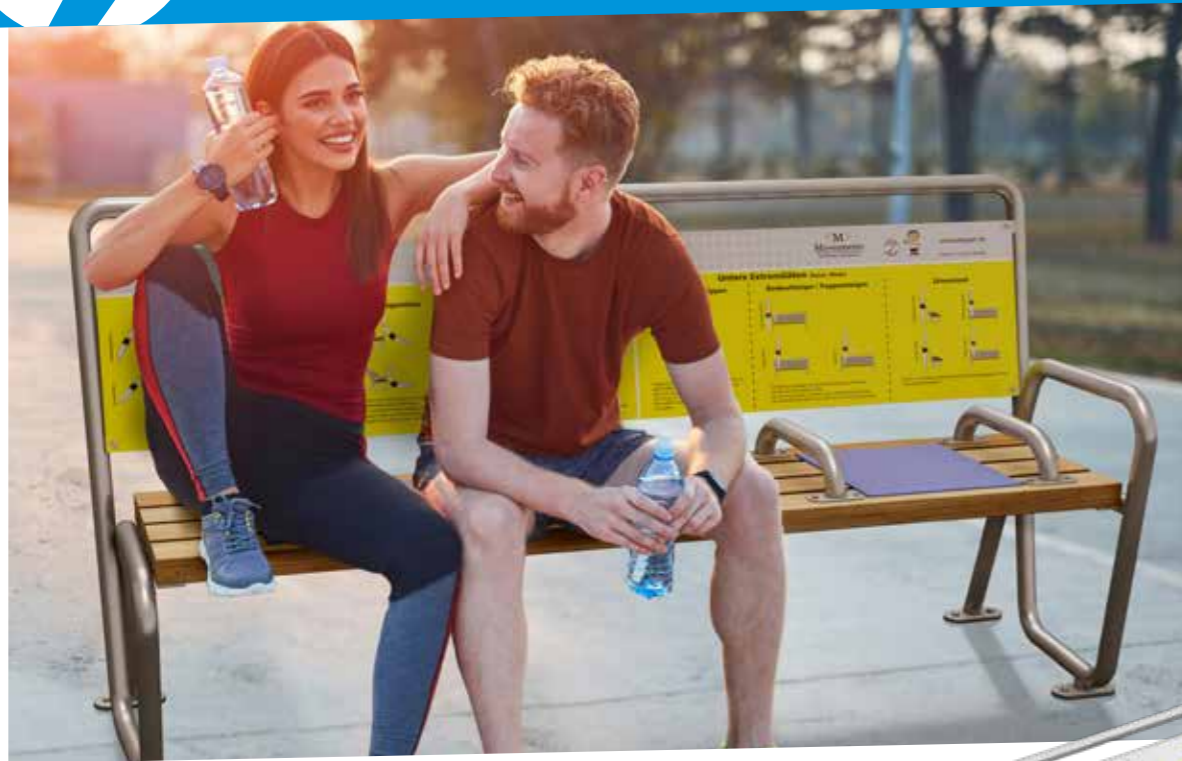

FITNESSBANK 2.0

14.02.205

⊕ 3,14 x 0,75 x 1,03m

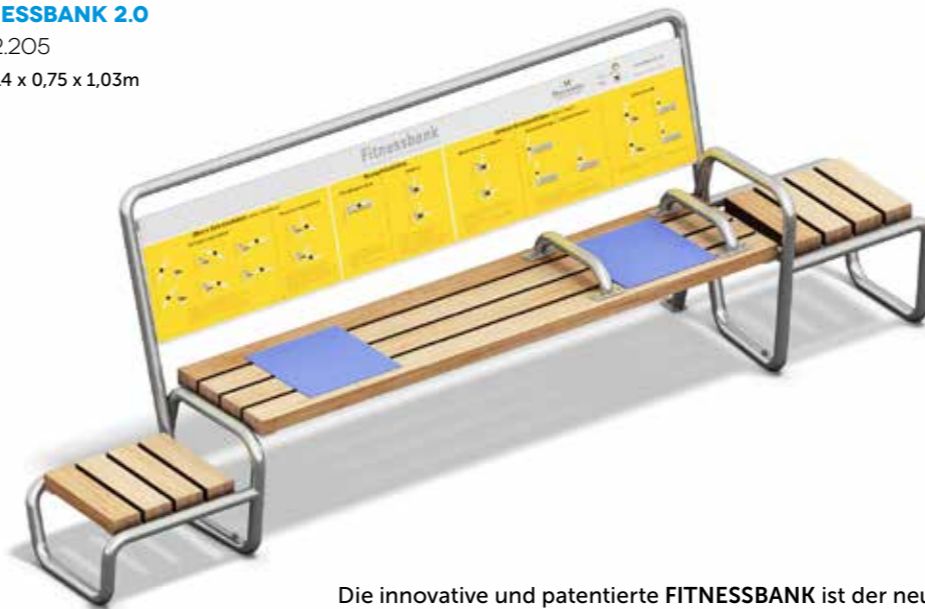

**FITNESSBANK
EXTRA TRAININGSFLÄCHE**

EXTRA TRAINING PLATFORM

14.02.205.001

⊕ 2,65 x 0,75 x 1,03 m



**FITNESSBANK
EXTRA STEPS-FLÄCHE**

EXTRA STEPS PLATFORM

14.02.205.002

⊕ 2,65 x 0,75 x 1,03 m

Die innovative und patentierte **FITNESSBANK** ist der neue Trend im Fitness- und Präventionsbereich für Jung und Alt! Durch ihr funktionales Design bietet sie ideale Trainingsbedingungen für ein abwechslungsreiches Fitnessprogramm im öffentlichen Raum, wie beispielsweise in der Stadt oder im Park. Das sportwissenschaftliche Konzept stellt ein multifunktionales Trainingsgerät für verschiedene Leistungsniveaus sowie eine bequeme Sitzmöglichkeit für Pausen dar, mit dem flächendeckend ein attraktives und niedrighwelliges Bewegungsangebot geschaffen wird.

The innovative and patented **FITNESS BENCH** is the new trend in fitness and prevention for young and old! With its functional design, it offers ideal training conditions for a varied fitness program in public spaces, such as in the city or in the park. The sport-scientific concept represents a multifunctional training device for different performance levels as well as a comfortable seating option for breaks, with which an attractive and low-threshold exercise offer is created area-wide.

FITNESSBANK

14.02.201

⊕ 2,15 x 0,75 x 1,03 m

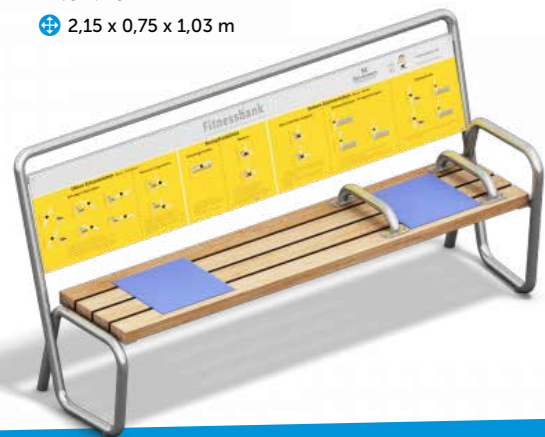

FITNESSBANK SR

14.02.206

⊕ 2,15 x 0,90 x 1,03 m



SPEZIAL ADDON

- Steps-Trainer
- Halterungen für Suspensionsbänder

SPEZIAL ADDON

- Step bars
- Holders for suspension bands





4FCIRCLE® FITNESS

Je nach Alter bewegt sich der Mensch anders, hat andere Motivationen und individuelle Bedürfnisse an Bewegung. Mit den beliebten 4FCIRCLE® Fitnessgeräten, multifunktionalen Sportanlagen und speziellen Lösungen für Calisthenics, OCR oder Parkour setzt PLAYPARC seit Jahren innovative Trends im modernen Sportstättenbau. Wir freuen uns immer wieder darüber, sportliche Visionen unserer Kunden realisieren zu können, die die Gesundheit fördern und für alle Menschen geeignet und erreichbar sind.

Depending on their age, people move differently, have different motivations and individual needs for exercise. With the popular 4FCIRCLE® fitness equipment, multifunctional sports facilities and special solutions for calisthenics, OCR or parkour, PLAYPARC has been setting innovative trends in modern sports facility construction for years. We are always pleased to be able to realize our customers' sporting visions, which promote health and are suitable and accessible for everyone.

CALISTHENICS

Bei der Planung von Sport- und Fitnessanlagen legen wir großen Wert auf Multifunktionalität, Sicherheit und Inklusion. Unsere CALISTHENICS-Anlagen bieten aktiven Trendsportlern optimale Trainingsvoraussetzungen und schaffen einen Sport-Ort, an dem Kraft, Ausdauer und Beweglichkeit trainiert werden können - unabhängig vom eigenen Leistungslevel.

When designing sports and fitness areas, we place great value on multifunctionality, safety and inclusion. Our CALISTHENICS facilities offer active trend athletes optimal training conditions and create a sports venue where strength, endurance and flexibility can be trained - regardless of the individual performance level.

MOBILPARC®

Der innovative Fitness-Trailer MOBILPARC® ist überall schnell aufgebaut. Die mobile Outdoor-Lösung für Fitness und Calisthenics überzeugt durch ihre standfeste, robuste Konstruktion und vielfältige Trainingsmöglichkeiten auf 360°. Mit der bebilderten Anleitung ist schnell ein mobiles Outdoor-Gym errichtet, in dem alle Muskelgruppen im Freien, an jedem Ort und zu jeder Zeit trainiert werden können.

The innovative fitness trailer MOBILPARC® is quickly set up anywhere. The mobile outdoor solution for fitness and calisthenics convinces with its stable, robust construction and diverse training possibilities on 360°. With the illustrated instructions, a mobile outdoor gym is quickly set up, in which all muscle groups can be trained outdoors, at every location and at any time.

PARKOUR + OCR

Für die wachsenden Communities und Vereine der modernen Individual-Trendsportarten PARKOUR und OCR planen wir gemeinsam mit erfahrenen Athleten multifunktionale Lösungen für den öffentlichen Raum. Mit Hinderniselementen aus langlebigem Holz und Stahl und Netzstrukturen bauen wir Ihren OCR-Parcours genau nach Ihren Bedürfnissen und Möglichkeiten. Die Beton-Module der ready to move Parkour-Anlagen wurden von deutschen PARKOUR-Pionieren entwickelt und bieten optimale Trainingsvoraussetzungen vom Cat-Leap bis zur Rolle.

For the growing communities and clubs of the modern individual trend sports PARKOUR and OCR, we plan multifunctional solutions for public spaces together with experienced athletes. With obstacle elements made of wood and steel and net structures, we build your OCR course exactly according to your needs and possibilities. The concrete modules of the ready to move parkour facilities were developed by German PARKOUR pioneers and offer optimal training conditions from cat-leap to roll.



4FCIRCLE®

Pionier der neuen Fitnessbewegung

Pioneer of the new fitness movement

Die Bedürfnisse der Menschen haben sich stark gewandelt. Alles scheint knapper geworden zu sein. Gefühl schrumpfen täglich Zeit und Raum. Fitness aber gehört mehr denn je zu den großen Wünschen und Zielen großer Kreise der Bevölkerung. Und zwar unabhängig von Alter, Geschlecht oder sozialem Hintergrund.

**Wir wollen Fit, Free, Fun and Function: 4F!
Jeder Parcours enthält 100% Bewegungskompetenz
= maximale Funktion**

People's needs have changed dramatically. Everything seems to be getting tighter. Feel time and space shrink every day. Fitness, however, is more than ever one of the great wishes and goals of large sections of the population. And that regardless of age, gender or social background.

**We want Fit, Free, Fun and Function: 4F!
Each course contains 100% of
movement competence = maximum
of function**

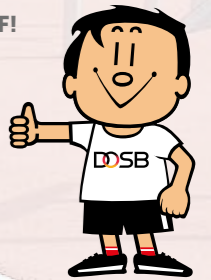



WIR BRINGEN MENSCHEN IN BEWEGUNG

Seit über 40 Jahren bringt PLAYPARC Menschen jeden Alters in Bewegung. Die Bedürfnisse von Athleten setzen wir in multifunktionale Sportanlagen um, die auch für viele Fitnessarten geeignet sind. Wir „verkaufen“ keine Produkte, sondern haben vom DOSB empfohlene Sport- und Bewegungskonzepte entwickelt und stehen ihnen von der ersten Planung an, als erfahrener Partner für modernen Sportstättenbau zur Seite. Gerne erstellen wir Ihnen eine individuell geplante Anlage, die alle ihre sportlichen Wünsche erfüllt.

OLYMPIA-STÜTZPUNKT DER ZUKUNFT

Nach zweijähriger Planungs- und Bauphase wurde am 16.6.2022 der Calisthenics Park am Standort Frankfurt (Oder) eröffnet. In enger Abstimmung mit den Bundesstützpunktleitern wurden die Sportgeräte zusammengestellt und entworfen. In einem symbolischen Akt wurde durch den Leiter des Olympiastützpunktes und des Sportzentrums Wilfried Lausch, dem Frankfurter Oberbürgermeister René Wilke, dem Vertreter des MBS Marcel Forch, dem Architekten Jens Beige und Oliver Seitz, dem Vertreter der Firma PLAYPARC der Parcours für die Athletinnen und Athleten des Olympiastützpunktes freigegeben.

WE GET PEOPLE ON THE MOVE

PLAYPARC has been getting people of all ages moving for over 40 years. We transform the needs of athletes into multifunctional sports facilities that are also suitable for many types of fitness. We do not „sell“ products, but have developed sports and exercise concepts recommended by the DOSB (German Sports Confederation) and are at your side from the initial planning stage as an experienced partner for modern sports facility construction. We will be happy to create an individually planned facility for you, which fulfills all your sporting wishes.

OLYMPIC TRAINING BASE OF THE FUTURE

After a two-year planning and construction phase, the Calisthenics Park at the Frankfurt (Oder) site was opened on 16.6.2022. The sports equipment was assembled and designed in close coordination with the federal base managers. In a symbolic act, the head of the Olympic base and the sports center Wilfried Lausch, the mayor of Frankfurt René Wilke, the representative of the MBS Marcel Forch, the architect Jens Beige and Oliver Seitz, the representative of the company PLAYPARC released the course for the athletes of the Olympic base.



„Gemeinsam mit 4FCIRCLE® haben wir mit dem Calisthenics-Park am Olympiastützpunkt Frankfurt (Oder) eine Freiluft-Trainingsmöglichkeit für ALLE unsere Olympioniken und Kader-/Athlet-innen, im Bereich Koordination, Geschicklichkeit, Kraft und Ausdauer entwickelt und realisiert.“

„Together with 4FCIRCLE® we have developed and realized the Calisthenics Park at the Olympic Base Frankfurt (Oder), an outdoor training facility for ALL our Olympians and squad/athletes, in the areas of coordination, dexterity, strength and endurance.“

Tino Buchholz - Objektleiter des Sportzentrums



WORK-OUT
FUN

INCLUSION
POWER

MOVEMENT
INDIVIDUAL TRAINING

CALISTHENICS
WARM-UP

MOBILITY
GYM

CONDITION

PHYSICAL
LITERACY

PLAY



PRÄVENTION
PREVENTION

COORDINATION



FUNCTION
FREE
STYLE

TRENDSPORTS

GESCHICKLICHKEIT
BEWEGUNG

OUTDOOR
FITNESS

HEALTH
GESUNDHEIT





„Das 4FCIRCLE®-Team entwickelt in enger Kooperation mit Projektpartnern und Kunden, ganzheitliche Bewegungsräume für ALLE denkbaren Nutzergruppen: Alt+Jung, Dick+Dünn, sportliche + spaßorientierte Bewegler. Aus sportwissenschaftlicher und gerätetechnischer Sicht entstehen so, auf Basis intensiver Nutzer- und Standortanalysen, Bewegungsparks und Calisthenicsanlagen, die exakt auf die anvisierte Nutzergruppe vor Ort abgestimmt sind.“

„The 4FCIRCLE® team develops in close cooperation with our project partners and customers, holistic movement spaces for ALL conceivable user groups, old+young, thick+thin, sporty + fun-oriented movers. From a sport-scientific and equipment-technical point of view, based on intensive user and site analysis, movement parks and calisthenics facilities are created, which are exactly tailored to the targeted user group on site.“

Oli Seitz





4F Kraft

Als Kraft bezeichnen wir die Fähigkeiten, die notwendig sind, um durch eigene Muskelkraft Widerstände zu überwinden oder sie entgegen der Schwerkraft zu halten. Körperliche Kraft kann durch regelmäßiges Training gestärkt werden. Gute Krafttrainingsgeräte ermöglichen beständige Steigerungsmöglichkeiten und arbeiten mit dem eigenen Körpergewicht.

4F Koordination

Als koordinative Fertigkeiten bezeichnen wir die motorischen Fähigkeiten, die notwendig sind, um koordinierte Bewegungen auszuführen. Durch die Nutzung guter koordinativer Lerngeräte, erhöht sich zum einen die Basis-Koordinationsfähigkeit und zum anderen bieten sie Möglichkeiten spezielle Fähigkeiten zu lernen.

4F Beweglichkeit

Als Mobilisation bezeichnen wir die Maßnahmen, die der Förderung und Erhaltung der Beweglichkeit und Bewegungsfähigkeit von Menschen dienen. Durch die Nutzung guter Mobilisationsgeräte kann dauerhaft die körperlich Autarkie und ein positives Bewegungs- und Lebensgefühl gefördert werden.

4F Ausdauer

Um die Ausdauer zu verbessern werden Aktivitäten über einen längeren Zeitraum ausgeführt. So wird die Herzfrequenz erhöht und die Durchblutung des Körpers gesteigert, was das Herz-Kreislauf-System stärkt. Dies hat verschiedene Vorteile, wie z.B. eine verbesserte Lungenfunktion, ein geringeres Risiko für Herzerkrankungen und Schlaganfälle, eine bessere Durchblutung und ein gesteigertes Immunsystem.

4F Strength

Force is the name given to those abilities which are necessary to overcome resistance through one's own muscle power or to hold it against gravity. Physical strength can be enhanced by regular training. Good power training equipment allows you to constantly increase your strength and work with your own body weight.

4F Coordination

Coordinative skills are those motoric skills that are necessary to carry out coordinated movements. By using good coordinative learning equipment, the basic coordinative ability is increased on the one hand and on the other hand they offer opportunities to learn special skills.

4F Mobility

We call mobilization those measures that serve to promote and maintain the mobility of people. The use of good mobilisation equipment can permanently promote physical self-sufficiency and a positive attitude to movement and life.

4F Endurance

To increase endurance, activities are performed over a longer period of time. This raises the heart rate and boosts blood flow to the body, which strengthens the cardiovascular system. This has several benefits, such as improved lung function, lower risk of heart disease and stroke, better blood circulation, and an increased immune system.

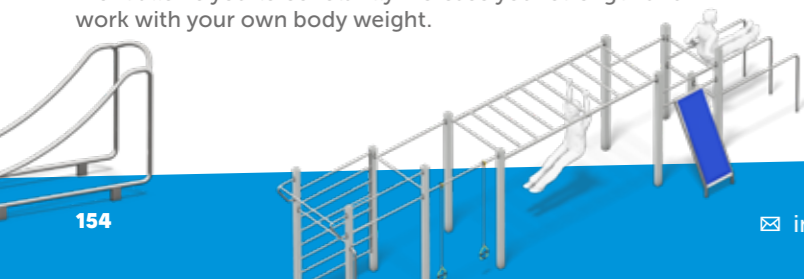



4F KRAFT

4F STRENGTH

MEHR KRAFT FÜR ALLE

MORE STRENGTH FOR ALL



DIPS-BARREN 2-FACH
DIPS-BARS DOUBLE
12.04.123
*Zum Einbetonieren/
to be set into concrete*
⊕ 2,33 x 0,72 x 1,45 m
⊕ 5,25 x 3,75 m H 1,45 m



DIPS-BARREN 2-FACH
DIPS-BARS DOUBLE
12.04.118
*Fallschutzplatten/
fall protection mats*
⊕ 2,33 x 0,61 x 1,45 m
⊕ 5,33 x 3,60 m H 1,45 m



DIPS-BARREN 3-FACH
DIPS-BARS TRIPLE
12.04.124
*Zum Einbetonieren/
to be set into concrete*
⊕ 2,33 x 1,16 x 1,45 m
⊕ 5,33 x 4,15 m H 1,30 m



DIPS-BARREN 3-FACH
DIPS-BARS TRIPLE
12.04.119
*Fallschutzplatten/
fall protection mats*
⊕ 2,33 x 1,16 x 1,45 m
⊕ 5,33 x 4,15 m H 1,30 m



LIEGESTÜTZ STATION
PUSH UPS
12.04.015
⊕ 1,50 x 0,63 x 1,00 m
⊕ 4,50 x 3,63 m
H 1,00 m



ARMZUG STATION
PULL UPS
12.04.016
⊕ 1,50 x 0,63 x 1,48 m
⊕ 4,50 x 3,63 m
H 1,48 m



SUSPENSION-HANGELLEITER
SUSPENSION-MONKEY BARS
12.04.126
⊕ 3,50 x 1,40 x 2,20 m
⊕ 7,67 x 5,33 m H 2,19 m



HANGELLEITER-KLEIN
MONKEY BARS SMALL
12.04.052
⊕ 2,35 x 0,95 x 2,26 m
⊕ 6,28 x 4,88 m
H 2,19 m



DIPS-BARREN INKLUSION
DIPS-BARS INKLUSION
12.04.135
*Zum Einbetonieren/
to be set into concrete*
⊕ 2,20 x 1,56 x 1,30 m
⊕ 5,20 x 4,56 m H 1,30 m | ♿



STATION KNEIEBEUGE
KNEE BEND SET OF 3
12.04.130
⊕ 0,77 x 0,53 x 0,93 m
⊕ 3,75 x 3,53 m H 0,50 m



STATION 3ER KNEIEBEUGE
KNEE BEND SET OF 3
12.04.027
⊕ 3,27 x 0,53 x 1,03 m
⊕ 6,25 x 3,53 m H 0,60 m



RÜCKENSTRECKEN UNIVERSAL
BACK STRETCHING
12.04.044
⊕ 2,17 x 0,78 x 0,85 m
⊕ 4,75 x 3,58 m H 0,85 m
*Fallschutzplatten
fall protection mats*



RUMPFSEITHEBEN
SIDEWINDER
12.04.014
⊕ 2,44 x 0,67 x 0,80 m
⊕ 5,44 x 3,67 m
H 0,80 m



STATION SITUPS
SITUPS STATION
12.04.013
⊕ 1,85 x 0,60 x 0,99 m
⊕ 4,85 x 3,60 m H 0,99 m



SITUPS-BEINHEBER-KOMBI
SIT UPS - LEG LIFTER
COMBINATION
12.04.113
⊕ 2,44 x 0,75 x 1,44 m
⊕ 5,45 x 3,75 m H 1,44 m

STATION STUFENTURM
BOUNCER/ TOWER
12.04.009
⊕ 4,74 x 2,76 x 4,11 m
⊕ 8,76 x 7,71 m
H 3,00 m



KNEIEBEUGE MIT WACKELPLATTE
KNEE BEND WITH WOBBLING PLATFORM
12.04.128
⊕ 0,77 x 0,53 x 0,93 m (Wackelplatte ø 40 cm)
⊕ 3,75 x 3,53 m H 0,50 m



STATION KLIMMZUG PLUS
PULL-UPS PLUS
12.04.040
⊕ 1,54 x 0,71 x 2,00 m ⊕ 5,14 x
4,31 m H 1,95 m (Griffhöhe space
required) ♿



STATION DEHNEN
STRETCHING
12.04.019
⊕ 1,15 x 0,80 x 1,98 m
⊕ 4,69 x 4,44 m H 1,98 m



STATION BEINHEBER
LEG LIFTER
12.04.025
⊕ 0,77 x 0,60 x 1,44 m
⊕ 3,77 x 3,64 m H 1,44 m

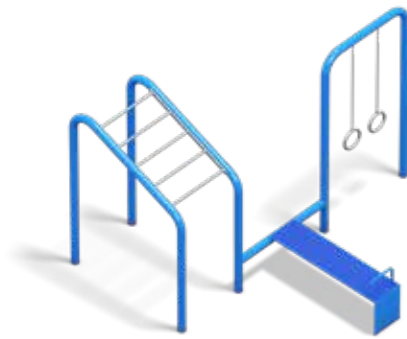

SUSPENSION POWER STATION

SUSPENSION POWER STATION

12.06.901.010

⊕ 4,55 x 4,08 x 3,16 m

⊕ 8,35 x 7,37 m ⊕ 2,70 m



STATION STÜTZSPRINGEN

JUMP UP BARS

12.04.011 **HOLZ** WOOD

⊕ 2,65 x 2,53 x 1,65 m

⊕ 5,55 x 5,42 m

⊕ 1,47 m (Griffhöhe Grip height)



STATION STÜTZSPRINGEN FERRUM

JUMP UP BARS FERRUM

12.04.150 **FERRUM**

⊕ 2,60 x 2,46 x 1,65 m

⊕ 5,51 x 5,38 m

⊕ 1,47 m (Griffhöhe Grip height)

TRIMMFIT®-Geräte sind eine optimale Ergänzung für alle sportlich ambitionierten Nutzer von Bewegungsgeräten im öffentlichen Raum.

Es handelt sich um ein **4FCIRCLE®**-Kombinationsgerät im Modul Kraft. Hier können alle Muskelgruppen im Schulter-, Rumpf- und Beinbereich trainiert werden. Das **TRIMMFIT®**-Gerät besteht aus hochwertigen Materialien. Die Aufbauten bestehen aus Edelstahl und sind auf einer mit Fallschutzmatten belegten Betonplatte vollständig montiert.

The **TRIMMFIT®** units are an optimal addition for all sporty ambitious users of movement equipment in public space.

It is a **4FCIRCLE®** combination device that belongs to the module "Force". All muscle groups in the shoulder, trunk and leg area can be trained with it. The **TRIMMFIT®** unit consists solely of high-quality materials. The metal parts are made of stainless steel and are fully assembled on a concrete slab covered with fall protection mats.



TRIMMFIT TRAININGSZONE

TRIMMFIT TRAINING ZONE

12.06.000

⊕ 4,00 x 1,13 x 1,53 m

⊕ 6,59 x 4,13 m ⊕ 1,50 m ⊕

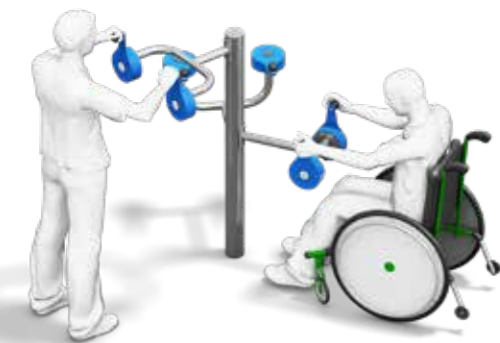

INKLUSIVES-OBERKÖRPER-ERGOMETER

INCLUSIVE ERGOMETER FOR UPPER

PART OF THE BODY

12.04.050

⊕ Ø 1,34 m x 1,59 m ⊕ Ø 4,40 m ⊕ 1,37 m ⊕

OBERKÖRPER-ERGOMETER

ERGOMETER UPPER BODY

12.04.032

⊕ Ø 1,34 x 1,59 m ⊕ Ø 4,40 m

⊕ Fallhöhe 1,37 m ⊕



BEIN-BEWEGER

LEG ERGOMETER

12.04.043

Lieferung ohne Bank.

Delivery without bench.

⊕ 0,54 x 0,50 x 0,33 m

⊕ 0,45 m

⊕ Fallschutzplatten fall protection mats



TRIMMFIT RUMPFTRAINER

TRIMMFIT

RUMPFTRAINER

12.06.001

⊕ 1,75 x 0,60 x 1,00 m

⊕ 4,75 x 3,58 m

⊕ 0,81 m ⊕





4F KOORDINATION

4F COORDINATION

MEHR KOORDINATION FÜR ALLE

MORE COORDINATION FOR ALL



ZIELWERFEN 3-FACH

12.04.008

Goal Challenge Triple

3 Wurfanlagen mit 3 verschiedenen Standflächen

3 throwing systems with 3 different platforms

⊕ 4,75 x 3,50 x 3,72 m ⊕ 7,75 x 6,50m ⊕ 0,42 m

ZIELWERFEN 1-FACH

12.04.108

Goal Challenge Double (no pic.)

1 Wurfanlage mit Einzelfederplatte,

1 throwing system with single spring platform

⊕ 3,25 x 0,50 x 3,72 m ⊕ 6,25 x 3,50 m ⊕ 0,42 m



STATION BALANCIER-STRECKE

BALANCING PARCOUR

12.04.001 **BALANCIERSTRECKE**, 8 M

BALANCING PARCOUR, 8 M

⊕ 8,27 x 2,21 x 1,18 m ⊕ 11,27 x 5,23 m ⊕ 0,40 m

12.04.101 **BALANCIERSTRECKE**, 4 M (O. ABB.)

BALANCING PARCOUR, 4 M (NO PIC.)

⊕ 4,12 x 2,23 x 1,18 m ⊕ 7,12 x 5,23 m ⊕ 0,40 m



STATION SLALOMSTRECKE

TYRE SLALOM

12.04.004

⊕ 9,20 x 3,60 x 3,13 m ⊕ 12,20 x 6,60 m ⊕ 0,00 m

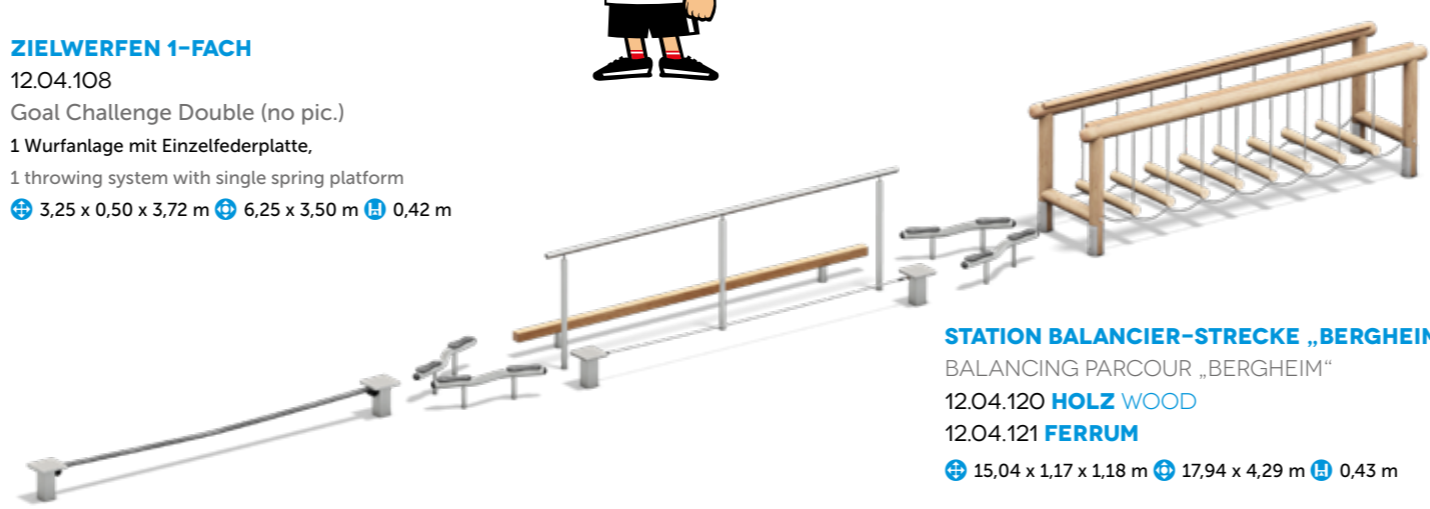

STATION BALANCIER-STRECKE „BERGHEIM“

BALANCING PARCOUR „BERGHEIM“

12.04.120 **HOLZ WOOD**

12.04.121 **FERRUM**

⊕ 15,04 x 1,17 x 1,18 m ⊕ 17,94 x 4,29 m ⊕ 0,43 m

STATION GEHSCHULE

FOOT TRAINER

12.04.046

⊕ 4,00 x 1,00 x 0,20 m

⊕ 7,00 x 4,00 m ⊕ 0,00 m ⊕



STATION SKIPPING-BAHN

SKIPPING- TRACK

12.04.045

⊕ 6,00 x 1,00 x 0,20 m (LxBxH LxWxH)

⊕ 9,00 x 4,00 m ⊕ 0,00 m





4F KOORDINATION

4F COORDINATION

MEHR FITNESS FÜR ALLE

MORE FITNESS FOR ALL

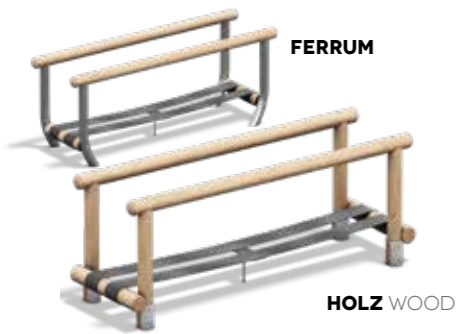

FERRUM

HOLZ WOOD

STATION SCHWINGSTREIFEN

SWING BRIDGE
 12.04.002 **HOLZ WOOD**
 12.04.152 **FERRUM**
 ⊕ 4,06 m x 1,00 m x 1,23 m ⊕ 7,06 m x 4,00 m
 ⊕ 0,40 m ⊕

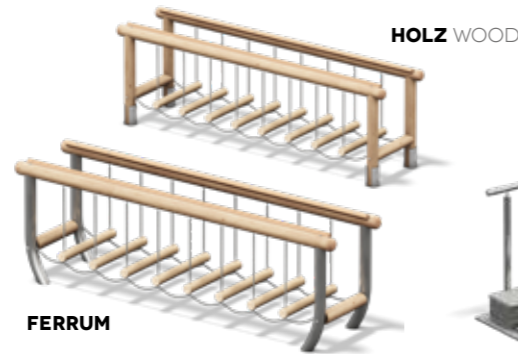

HOLZ WOOD

FERRUM

STATION HÄNGELAUF-BRÜCKE

BALANCE BRIDGE
 12.04.003 **HOLZ WOOD**
 12.04.151 **FERRUM**
 ⊕ 4,03 m x 0,94 m x 1,26 ⊕ 7,00 m x 3,94 m
 ⊕ 0,43 m ⊕



STATION PEDALOSTRECKE

PEDALO
 12.04.107
 ⊕ 4,02 x 0,91 x 1,16 m ⊕ 7,02 x 3,91 m ⊕ 0,25 m

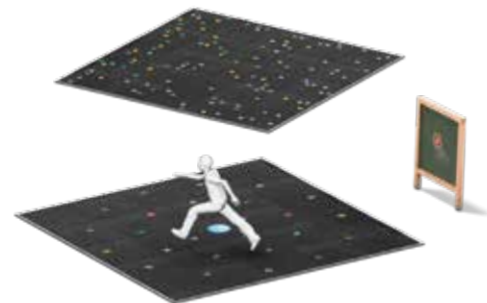

STATION SPRINGFELD

JUMPINGFIELD
 12.04.005 **SPRINGFELD INKL. MALTAFFEL**
 JUMPING FIELD INCL. PAINTING BOARD
 12.04.105 **BUCHSTABENFELD**
 LETTER FIELD
 ⊕ 5,07 m x 5,07 m ⊕ 8,07 m x 8,07 m ⊕ 0,00 m'

STATION BALANCIER-STRECKE „TRIMMY II“

BALANCING PARCOUR „TRIMMY II“
 12.04.111 **HOLZ WOOD**
 12.04.112 **FERRUM**
 ⊕ 13,21 x 1,16 x 1,18 m ⊕ 16,21 x 4,12 m
 ⊕ 0,43 m ⊕

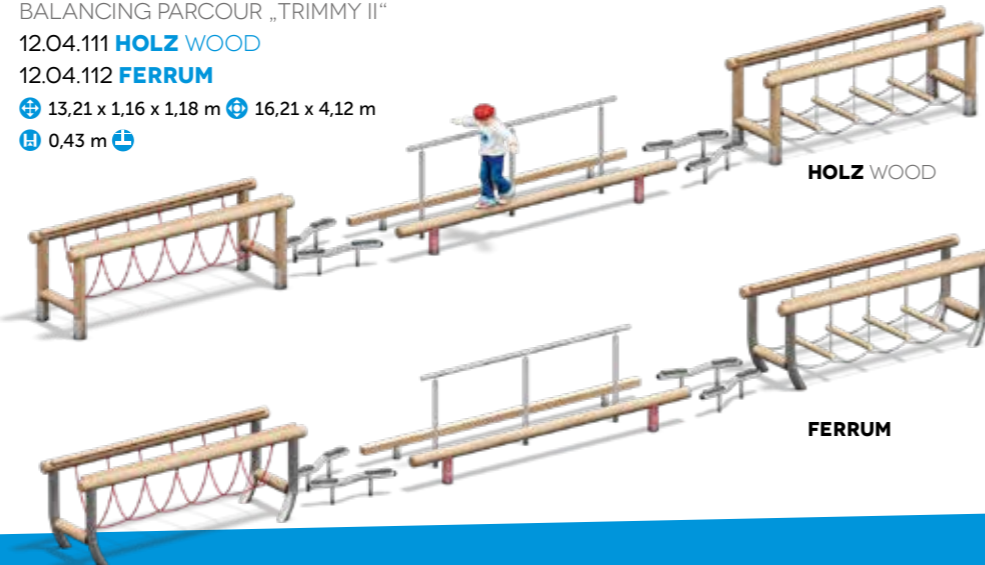

HOLZ WOOD

FERRUM



STATION HEISSER DRAHT MINI

HOT WIRE MINI
 12.04.129
 ⊕ 2,37 x 1,83 x 1,74 m ⊕ 5,14 x 4,83 m ⊕ 0,17 m



STATION SCHWEBENDE PLATTFORM

FLOATING PLATFORM
 12.04.030
 ⊕ 1,24 x 0,90 x 1,20 m ⊕ 4,24 x 3,90 m ⊕ 0,26 m



STATION SLACKLINE 4M

06.01.045
 ⊕ 4,12 x 0,24 x 0,40 m ⊕ 7,12 x 3,24 m
 ⊕ 0,40 m ⊕

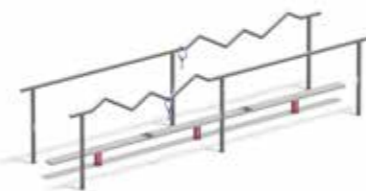

STATION HEISSER DRAHT

HOT WIRE
 12.04.029
 ⊕ 6,08 x 1,05 x 1,39 m ⊕ 9,09 x 4,05 m
 ⊕ 0,94 m

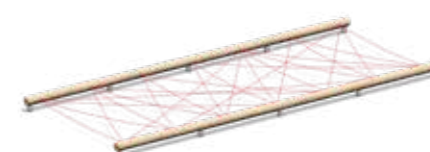

STATION SPINNENNETZ

SPIDER NET
 12.04.031
 ⊕ 6,00 x 2,00 x 0,35 m ⊕ 9,00 x 5,00 m
 ⊕ 0,35 m



STATION REIFENLAUFEN

TYRE CHALLENGE
 12.04.006
 ⊕ 10,00 x 2,25 x 0,06 m ⊕ 13,00 x 5,25 m
 ⊕ 0,06 m



4F MOBILISATION

4F MOBILISATION

AKTIVIERUNG + BEWEGUNG

ACTIVATION + MOVEMENT



STATION HÜFTSCHWUNG HIP SWINGER
12.04.038
⊕ 2,06 x 0,80 x 1,48 m ⊕ 5,07 x 3,62 m
⊕ 0,69 m 🛡️ Fallschutzmatten fall protection mats



STATION WELLENLAUFEN
WAVE RIDER
12.04.037
⊕ 2,03 x 0,75 x 1,48 m
⊕ 4,96 m x 3,39 m ⊕ 0,59 m
🛡️ Fallschutzmatten fall protection mats



STATION „SWING“
ADULT-SWING
12.04.500
⊕ 2,28 m x 4,54 m x 3,00 m (L x B x H)
⊕ 4,54 m x 8,72 m ⊕ 1,70 m



STATION DEHNEN
STRETCHING
12.04.019
⊕ 1,15 x 0,80 x 1,98 m
⊕ 4,69 x 4,44 m ⊕ 1,98 m

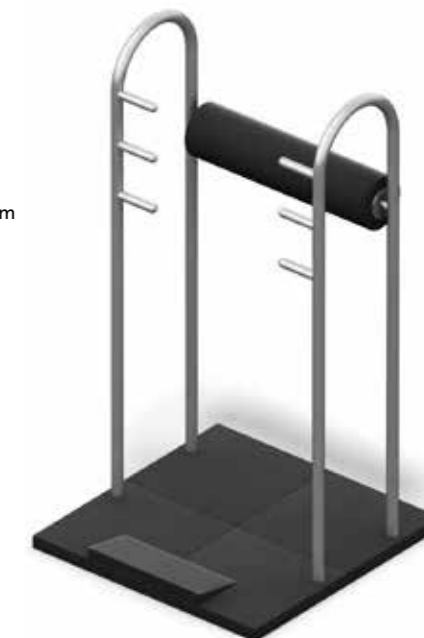

FASZIENTRAINER OBERKÖRPER
FACIAL TRAINER UPPER BODY
12.04.801
⊕ 1,00 x 1,00 x 1,87 m
⊕ 4,00 x 4,00 m ⊕ 1,38 m

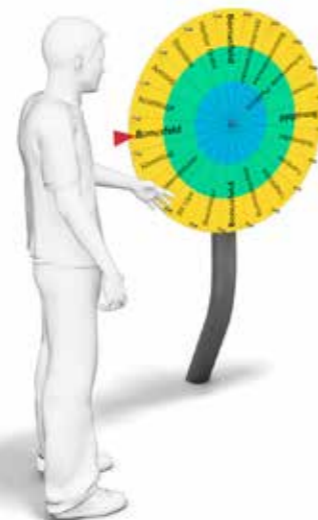

4F-PLAY
FITNESS-GLÜCKSRAD
WHEEL OF FORTUNE
12.04.049
⊕ 1,22 x 0,31 x 1,76 m
⊕ 4,22 x 3,31 m 🛡️



FASZIENTRAINER LIEGEND
FACIAL TRAINER HORIZONTAL
12.04.802
⊕ 1,40 x 2,05 x 3,02 m ⊕ 7,00 x 4,00 m



FASZIENTRAINER BEINE
FACIAL TRAINER LEGS
12.04.800
⊕ 1,00 x 1,00 x 1,25 m hoch
⊕ 4,00 x 4,00 m ⊕ 0,83 m





CALISTHENICS

IMPRESSIONEN IMPRESSIONS



INDIVIDUELLE LÖSUNGEN FÜR INDIVIDUELLEN SPORT

CALISTHENICS „TURNKREISEL“
Mönchengladbach, Germany



INDIVIDUAL SOLUTIONS FOR INDIVIDUAL SPORTS





BEISPIEL/EXAMPLE

VERBINDUNGSTECHNIK

Bars and Calisthenics-Elemente werden dauerhaft mit den Pfosten verschraubt. Wir nutzen dafür eine VA-Schraube mit zusätzlichem Steckschutz, die nur mit Spezialwerkzeug gelöst werden kann. Zusätzlich werden die Schrauben bei der Montage noch verklebt. Bei dem 4FCIRCLE®-Calisthenics-Verbindungssystem ist es möglich, dass vier Bars an einem Standpfosten in exakt der gleichen Höhe befestigt werden können, ohne dass die Verbindungsschrauben in Konflikt miteinander geraten.

CONNECTION TECHNOLOGY

Bars and Calisthenics elements are permanently screwed to the posts. We use a stainless steel screw with additional plug-in protection, which can only be loosened with special tools. In addition to that, the screws are glued during assembly. With the 4FCIRCLE®-Calisthenics connection system, it is possible that four bars can be attached to a post at exactly the same height without the connecting screws coming into conflict with each other.

SICHERHEIT

4FCIRCLE®-Calisthenics-Anlagen entsprechen allen Sicherheitsnormen (DIN-EN 16630 (in Kombination mit einem Anleitungsschild) und DIN-EN 1176), die für den Einsatz im öffentlichen Raum notwendig sind. Wir sind Mitglied in nationalen und internationalen Normungsgremien. Im Fallbereich der Anlage ist ein falldämpfender Bodenbelag vorgeschrieben. Des Weiteren gewährleisten zusätzliche Traversen im Fundamentbereich die Standsicherheit, auch bei großen Nutzergruppen und zeitgleicher dynamischer Belastung.

SAFETY

4FCIRCLE®-Calisthenics systems comply with all safety standards (DIN-EN 16630 (in combination with an instruction sign) and DIN-EN 1176) required for use in public spaces. We are a member of national and international standards committees. A fall-damping floor covering is prescribed in the fall area of the system. In addition, additional trusses in the foundation area ensure stability, even with large user groups and simultaneous dynamic loading.

Individuelle Gestaltungsmöglichkeiten Individual design options

MATERIAL, FARBEN UND BESCHICHTUNGEN

Als Standpfosten verwenden wir Stahlrohre mit einem 10 x 10 cm verz. Profil. Die oberen Enden sind mit einer vollverschweißten Kappe verdeckt. Die Pfosten können zusätzlich mit Aufpreis in RAL-Farben pulverbeschichtet werden. Als Material für die Bars, Leitern und allen Funktionselementen verwenden wir hoch qualitative Edelstahlrohre aus V2A. Unter den Nutzern ist das Grundmaterial der Bars teilweise umstritten. Um den unterschiedlichen Bedürfnissen der Nutzer zu genügen, können die Bars auch pulverbeschichtet werden. Dies ist grundsätzlich in allen gängigen RAL-Farben möglich.

MATERIAL, COLORS AND COATINGS

As posts we use steel tubes with a 10 x 10 cm zinc profile. The upper ends are covered with a fully welded cap. The posts can also be powder-coated in RAL colours for an additional charge. As material for the bars, ladders and all functional elements we use high-quality stainless-steel tubes made of V2A. Among the users the basic material of the bars is partly controversial. In order to meet the different needs of the users, the bars can also be powder-coated. This is basically possible in all common RAL colours.

RAL5015

RAL1016

RAL6017

RAL2005

RAL3002

RAL9017

INDIVIDUALITÄT MADE IN GERMANY

Unsere Anlagen sind auf die Bedürfnisse des Kunden abgestimmt und somit individuell. Natürlich gibt es gewisse Standardisierungen bei den Abmessungen, die von Calisthenics-Sportlern festgelegt wurden, um einer möglichst breiten Nutzergruppe optimale Trainings- und Wettbewerbssituationen zu bieten. Viele unserer Parks sind Unikate und werden in unserer Produktionsstätte in NRW/Deutschland gefertigt.

INDIVIDUALITY MADE IN GERMANY

Our systems are tailored to the needs of the customer and therefore individual. Of course, there are certain standardizations in the dimensions that have been defined by Calisthenics athletes in order to offer the broadest possible user group optimal training and competition situations. Many of our parks are unique and are manufactured in our production facility in NRW/Germany.



CALISTHENICS-ALLROUND

12.06.100

FUNKTION FUNCTION

Trainieren von Kraft und Beweglichkeit aller Muskelgruppen.
Training of strength and movability of all body muscle groups.

⊕ 5,72 m x 5,45 m x 3,02 m ⊕ 9,69 m x 10,01 m ⊕ 2,95 m

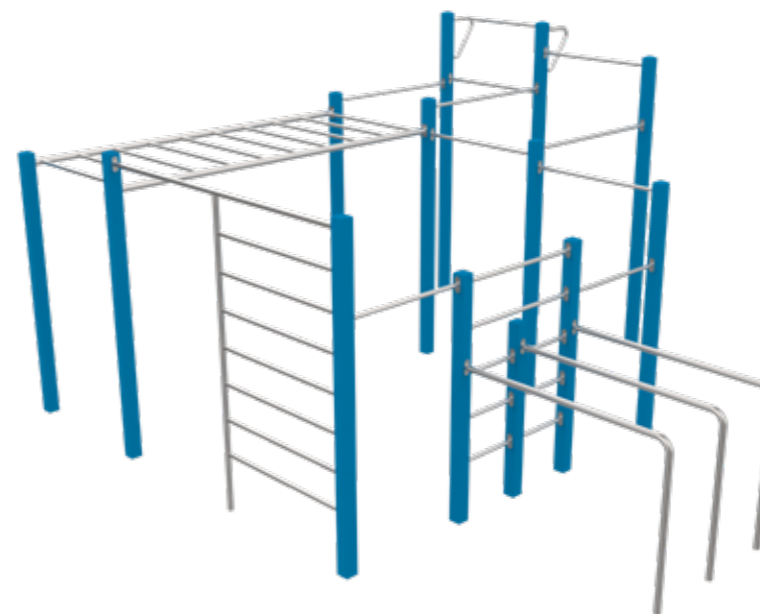

CALISTHENICS-ALLROUND

12.06.108

HOLZ WOOD



MATERIAL

STANGEN EDELSTAHL

Verschiedene Oberflächen-Veredelungen für unterschiedlichen Grip erhältlich.

BARS STAINLESS STEEL

Different surface treatments for different grip available.

PFOSTEN POLES

- verzinkter Stahl galvanized steel
- verzinkter und pulverbeschichteter Stahl galvanized and powder-coated steel
- Edelstahl stainless steel
- unbehandeltes Holz (Robinie oder Bellinga)



Calisthenics ist ein Ganzkörpertraining ohne großen technischen Aufwand! Dabei handelt es sich um sehr turnerische Kraft- und Körperübungen, die mit dem eigenen Körpergewicht und teilweise mit Zusatzgewichten ausgeübt werden. Calisthenics ist ein sehr individueller Sport und so sind auch unsere Anlagen: Stellen Sie sich Ihre eigene Calisthenics-Anlage nach Ihren Bedürfnissen und Möglichkeiten zusammen. Wir erstellen Ihr individuelles Gerät, damit Sie sich auf den Sport konzentrieren können. Überlassen Sie Konstruktion, Sicherheitsfragen und Planung ruhig uns.

Calisthenics is a full body workout without much technical effort! It includes very gymnastic strength and body exercises that are performed with your own body weight and sometimes with additional weights. Calisthenics is a very individual sport and so are our facilities: Create your own Calisthenics facility according to your needs and possibilities. We create your individual equipment so you can focus on the sport. Leave construction, safety issues and planning quietly to us.

Alle CALISTHENICS-Anlagen sind neben der Basis-Version aus feuerverzinktem Stahl auch zusätzlich pulverbeschichtet (RAL-Farben) erhältlich.



Sonderfarben auf Anfrage / special colors on request

All CALISTHENICS units are optionally available with powder-coated steel (RAL colors) in addition to the basic galvanized steel version.





CALISTHENICS-ALLROUND-PLUS

12.06.102

FUNKTION FUNCTION

Trainieren von Kraft und Beweglichkeit aller Muskelgruppen.
Training of strength and movability of all body muscle groups.

⊕ 8,55 x 4,93 x 3,02 m ⊕ 12,02 x 9,24 m ⊕ 2,96 m

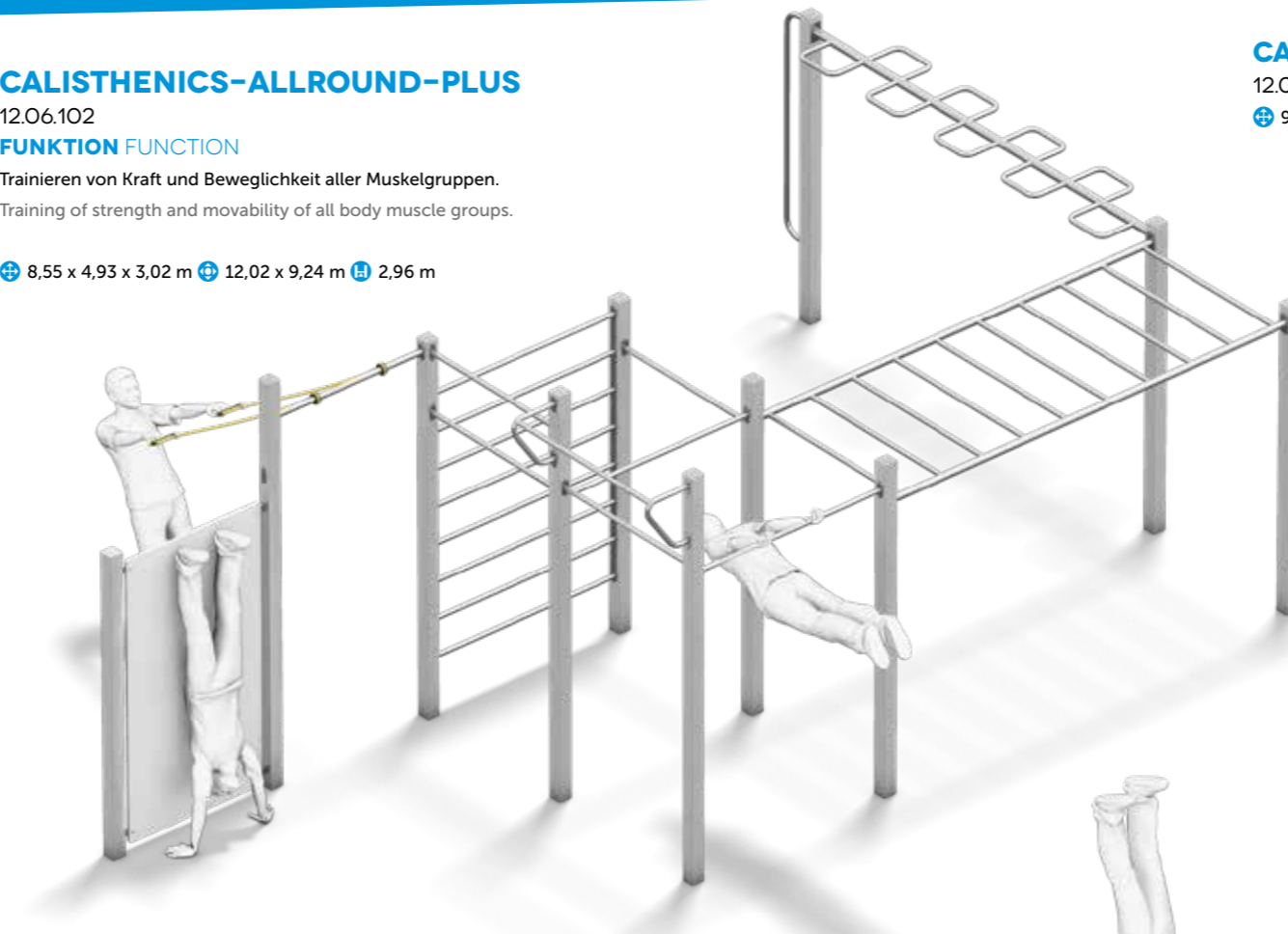

CALISTHENICS-ENTERPRISE

12.06.151

⊕ 9,05 x 3,96 x 2,80 m ⊕ 12,98 x 8,79m ⊕ 2,80 m



DIPS-BARREN INKLUSION

DIPS-BARS INKLUSION

12.04.135

Zum Einbetonieren/
to be set into concrete

⊕ 2,20 x 1,56 x 1,30 m

⊕ 5,20 x 4,56 m ⊕ 1,30 m | ♿



MEHR DIPS-BARREN AUF SEITE 156

MORE DIPS BARS ON PAGE 156

OPTIMIERT FÜR WEIGHTED CALISTHENICS

OPTIMIZED FOR WEIGHTED CALISTHENICS



LOW BARS LONG

12.06.170.002

⊕ 1,40 x 0,75 x 0,30 m

⊕ 4,40 x 3,75 m

⊕ 0,30 m



HANDSTANDBÜGEL

HANDSTAND BARS

12.06.170

⊕ 0,65 x 0,60 m

⊕ 3,65 x 3,60 m

⊕ 0,30 m



PUSH UP BARS 4-FACH

PUSH-UP-BARS 4X

12.06.129

⊕ 6,50 x 0,10 x 1,16 m

⊕ 9,50 x 3,10 m

⊕ 0,20/0,50/0,80/1,10 m

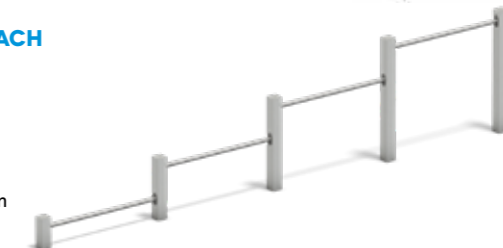

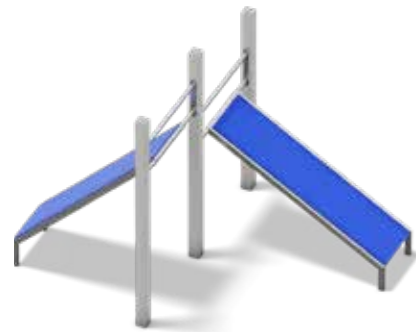

DOPPEL-BANK-SCHRÄG 30°/ 40°

DOUBLE BENCH 30°/ 40°

12.06.171

⊕ 2,30 x 2,47 m ⊕ 5,30 x 5,48 m ⊕ 1,66 m



CALISTHENICS-FÜNFECK

CALISTHENICS-PENTAGON

12.06.136

⊕ 4,22 x 3,55 x 2,46 m ⊕ 7,28 x 6,59 m ⊕ 2,40 m



CALISTHENICS-BASIC

12.06.110

⊕ 1,40 x 2,05 x 3,02 m hoch

⊕ 6,33 x 6,61 m ⊕ 2,95 m



CALISTHENICS-MINI

12.06.105

⊕ 2,70 x 2,05 x 3,02 m ⊕ 7,43 x 6,50 m

⊕ 2,95 m



CALISTHENICS BASIC PLUS PUSH-UPS

12.06.115

⊕ 2,70 x 3,11 x 3,02 m ⊕ 7,47 x 7,07 m

⊕ 2,95 m



CALISTHENICS-LINE LANG

CALISTHENICS-LINE LONG

12.06.128

⊕ 10,07 x 2,16 x 3,02 m ⊕ 14,05 x 6,00

⊕ 2,95 m



SQUAT-PLATTFORM

SQUAT-PLATFORM

12.06.166

⊕ 1,80 x 0,69 x 0,60 m

⊕ 4,80 x 3,69 m ⊕ 0,60 m



SQUAT-PLATTFORM PRO

SQUAT-PLATFORM

12.06.169

⊕ 2,92 x 0,69 x 0,97 m

⊕ 5,91x3,69 m ⊕ 0,97 m

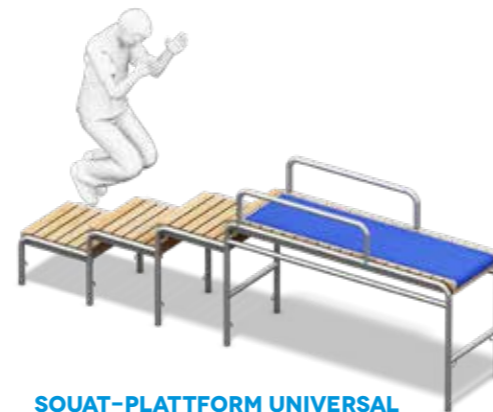

SQUAT-PLATTFORM UNIVERSAL

SQUAT-PLATFORM

12.06.173

⊕ 3,74 x 0,69 x 1,28 m

⊕ 6,74 x 3,69 m ⊕ 0,99 m



SQUAT-BOX 3ER-SET

SQUAT BOX SET OF 3

12.06.177

⊕ 2,60 x 0,50 m ⊕ 5,60 x 3,50 m

⊕ 0,30 m, 0,40 m, 0,50 m

CALISTHENICS-DISCOVERY

12.06.150

⊕ 6,02 x 5,70 x 3,00 m

⊕ 10,10 x 9,70 m

⊕ 2,95 m





CALISTHENICS

KRAFT + AUSDAUER STRENGTH + ENDURANCE

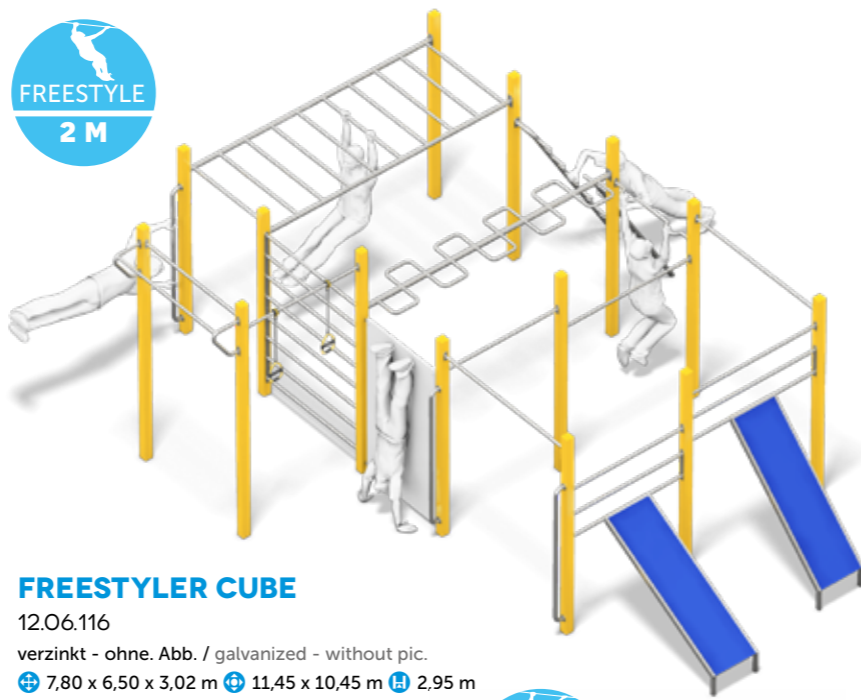

FREESTYLER CUBE

12.06.116

verzinkt - ohne Abb. / galvanized - without pic.

⊕ 7,80 x 6,50 x 3,02 m ⊕ 11,45 x 10,45 m ⊕ 2,95 m

Farbvariante auf Anfrage / color version on request



CALISTHENICS-STATION GET UP

12.06.179

⊕ 7,05 x 1,40 x 3,04 m ⊕ 11,08 x 6,33 m

⊕ 2,96 m

BAUCH-SCHRÄG PARC XL-B

PUSH-UP-BARS 4X

12.06.402

⊕ 5,50 x 3,00 x 2,82 m ⊕ 9,20 x 6,36 m ⊕ 2,54 m



HYPER CRAZY BARS

12.06.126

⊕ 2,70 x 8,47 x 3,02 m

⊕ 7,17 x 12,45 m ⊕ 2,95 m



CALISTHENICS LINIE KURZ

CALISTHENICS LINE SHORT

12.06.132

⊕ 8,47 x 1,40 x 2,26 m ⊕ 9,99 x 5,33 m

⊕ 2,20 m



CALISTHENICS STAND-UPS

12.06.124

⊕ 4,93 x 3,30 x 2,47 m ⊕ 8,97 x 7,50 m

⊕ 2,40 m

CALISTHENICS-ALLROUND PUSH-UP

CALISTHENICS-ALLROUND PUSH UP

12.06.101

⊕ 5,06 x 5,45 x 2,95 m

⊕ 8,99 x 9,99 m

⊕ 2,96 m



Alle CALISTHENICS-Anlagen sind neben der Basis-Version aus feuerverzinktem Stahl auch zusätzlich pulverbeschichtet (RAL-Farben) erhältlich.

RAL5015 RAL1016 RAL6017 RAL2005 RAL3002 RAL9017

Sonderfarben auf Anfrage / special colors on request

All CALISTHENICS units are optionally available with powder-coated steel (RAL colors) in addition to the basic galvanized steel version.

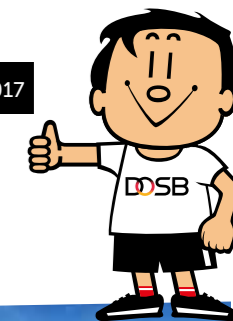

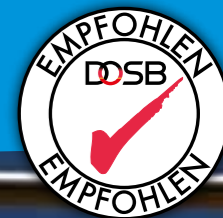

ALLTOGETHER 1

12.06.180

⊕ 5,20 x 4,00 x 2,20 m

⊕ 9,00 x 7,50 m

⊕ 2,12 m



ALLTOGETHER 2

12.06.181

⊕ 9,90 x 7,40 x 2,60 m

⊕ 13,60 x 11,50 m

⊕ 2,50 m



EPDM + AGILITY PATTERNS
EPDM + AGILITY PATTERNS

ALLTOGETHER 4

12.06.183.001 (RAL)

verzinkt - ohne. Abb. galvanized - without pic.

⊕ 8,40 x 2,70 x 3,00 m

⊕ 12,40 x 7,20 m ⊕ 2,95 m

Farbvariante auf Anfrage
color version on request



**2-LEVEL DIPS-BARS
FÜR ALLE STATIONEN ERHÄLTlich
AVAILABLE FOR ALL STATIONS**



ALLTOGETHER 3

12.06.182

⊕ 6,50 x 7,00 x 3,00 m

⊕ 11,20 x 11,00 m

⊕ 2,95 m





CALISTHENICS

ADDONS CALISTHENICS NO PAIN NO GAIN



CALISTHENICS BEYOND

12.06.103

- ⊕ 6,10 x 5,72 x 3,02 m
- ⊕ 10,01 x 9,69 m
- ⊕ 2,95 m

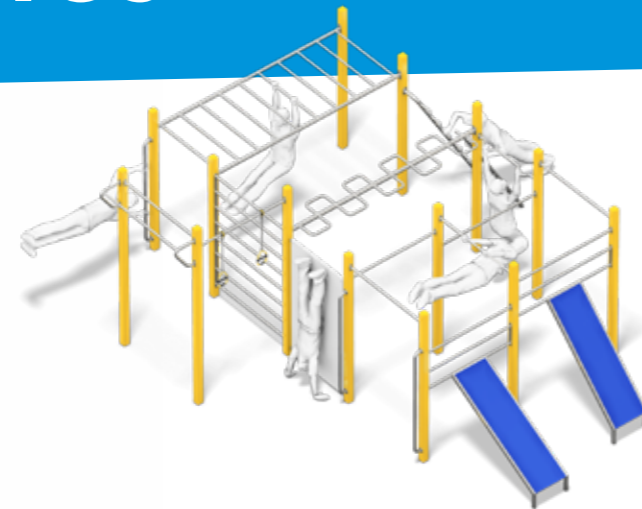
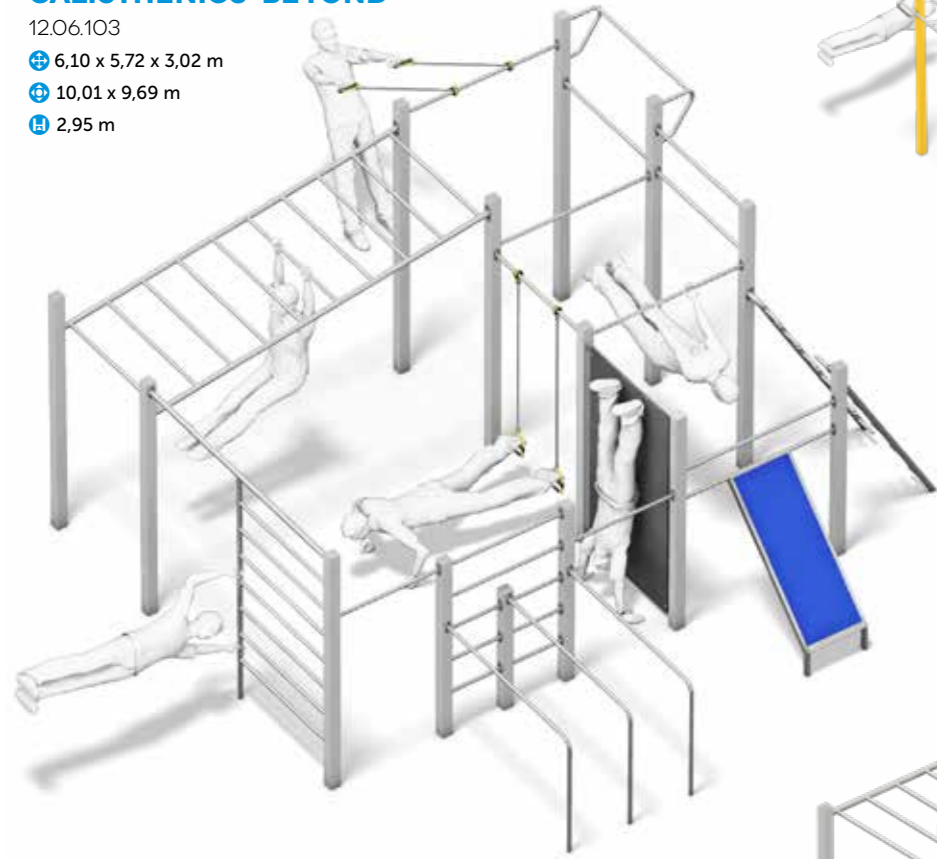

CALISTHENICS CUBE

12.06.104

- ⊕ 7,20 x 6,50 x 3,02 m
- ⊕ 10,85 x 10,45 m ⊕ 2,95 m

Farbvariante auf Anfrage / color version on request

CALISTHENICS CROSS-OVER

12.06.122

- ⊕ 9,77 x 5,05 x 3,02 m
- ⊕ 13,75 x 8,88 m ⊕ 2,95 m

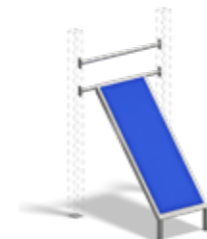
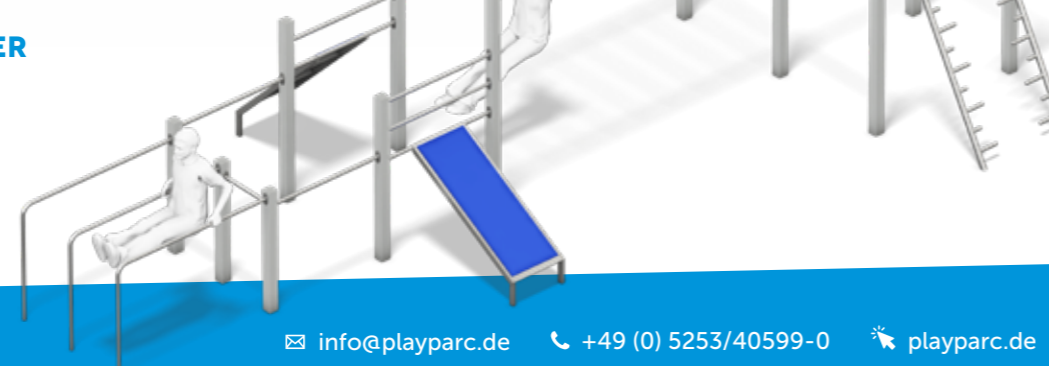

ADDON BAUCH-SCHRÄGBANK 45°

INCLINED BENCH 30°

88.06.130
ohne Standpfosten
without posts (not shown)

12.06.230
mit Standpfosten (o. Abb.)
with posts (not shown)

ADDON BAUCH-SCHRÄGBANK 60°

INCLINED BENCH 60°

88.06.131
ohne Standpfosten (o. Abb.)
without posts (not shown)

12.06.231
mit Standpfosten (o. Abb.)
with posts (not shown)

ADDON BAUCH-SCHRÄGBANK 30°

INCLINED BENCH 30°

88.06.132
ohne Standpfosten
without posts (not shown)

12.06.232
mit Standpfosten (o. Abb.)
with posts (not shown)



ADD ON PUSH-UPS/ ROW-UPS

88.06.900
ohne Standpfosten without posts

12.06.900
mit Standpfosten with posts (not shown)

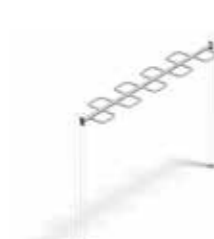

ADD ON BOGENHANGEL-LEITER

LADDER
88.06.133
Länge 3,30 m ohne Standpfosten
Length 3.30 m without posts

88.06.135
Länge 1,50 m ohne Standpfosten
Length 1,50 m without posts

12.06.172
Länge 3,50 m mit Standpfosten (o. Abb.)
Length 3.50 m with posts (not shown)



ADDON FREESTYLE STANGE 2M

FREESTYLE BAR 2M

82.06.117
ohne Standpfosten without posts

WORK OUT ADDONS auf Anfrage / on request

- BATTLE-ROPE
- BALL TARGET
- LANGHANTEL-HALTERUNG
- BARBELL RACK



ADDON SUSPENSIONSENSEN-RINGE

SUSPENSIONEN-RINGS
88.06.175



ADD ON HANDSTANDWAND

HANDSTAND WALL

88.06.177

ohne Standpfosten without posts

12.06.277

mit Standpfosten (o. Abb.)
with posts (not shown)





4F SCHILDER + ANLEITUNGEN

INFORMATION AND INSTRUCTION SIGNS

WETTERSCHUTZ

RAIN SHELTER



ZUBEHÖR/BESCHILDERUNG

ACCESSORY/SIGNAGE

Ein wesentlicher Aspekt bei der Umsetzung und Nutzung des sportwissenschaftlichen Konzepts sind klare, verständliche Übungsanleitungen in verschiedenen Schwierigkeitsstufen nebst gut erkennbarer Grafiken.

A key aspect of the implementation and use of the sport-scientific concept are clear and easy to understand exercise descriptions in different levels of difficulty, along with well-recognizable graphics.



STATIONSSCHILD
INSTRUCTION SIGN
12.04.021

A1-Grafik inkl. Trägergestell
A1-graphic incl. frame

Das Stationsschild besteht aus einem Trägergestell 12.04.901 und einem entsprechenden Anleitungsschild 12.08.XXX. Jede 4FCIRCLE®-Station hat eine individuelle Anleitungstafel, auf der beschrieben wird, wie der Nutzer die Geräte für professionelles Training einsetzen und nach eigenem Leistungsstand steigern kann.

The station sign consists of a support frame 12.04.901 and a corresponding instruction sign 12.08.XXX. For each 4FCIRCLE® unit there is an individual instruction sign available. It describes how the user can use the equipment for professional training and increase his own performance level.



EINLEITUNGSTAFEL
INTRODUCTION SIGN
12.04.022

A0-Grafik inkl. Trägergestell
A1-graphic incl. zined frame

Einleitungstafel bestehend aus: Trägergestell 12.04.902 und Einleitungstafel 12.04.903. Im Eingangsbereich gibt es eine detaillierte Eingangstafel, analog zu den einzelnen Stationen, die den Nutzer durch den Parcours leitet.

Introduction board consisting of: support frame 12.04.902 and introduction board 12.04.903. In the entrance area there is a detailed entry panel, which explains the parcour and the individual modules that guide the user through the course.



WETTERSCHUTZ REFUGIO
RAIN SHELTER REFUGIO
14.02.989
⊕ 3,60 x 2,45 x 2,70 m



CALISTHENICS-ANLEITUNGSTAFEL A0
CALISTHENICS INSTRUCTION SIGN A0
12.06.060

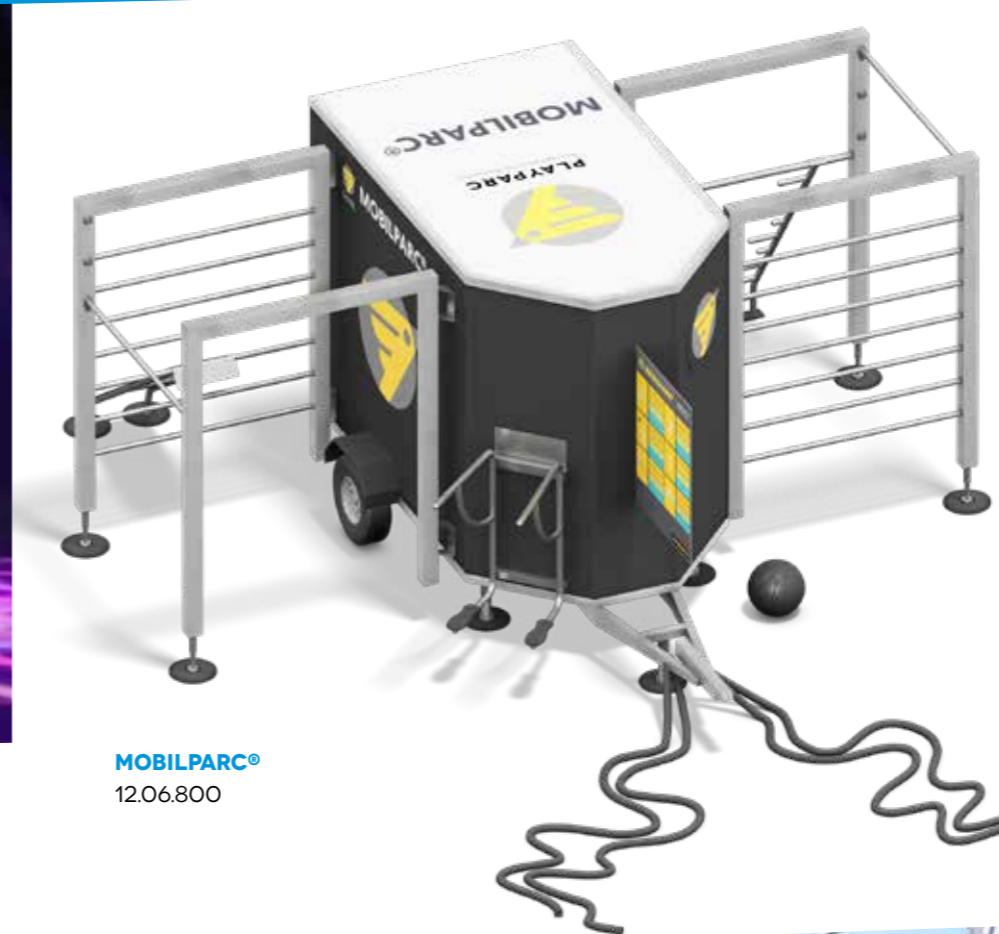

MOBILPARC®
12.06.800

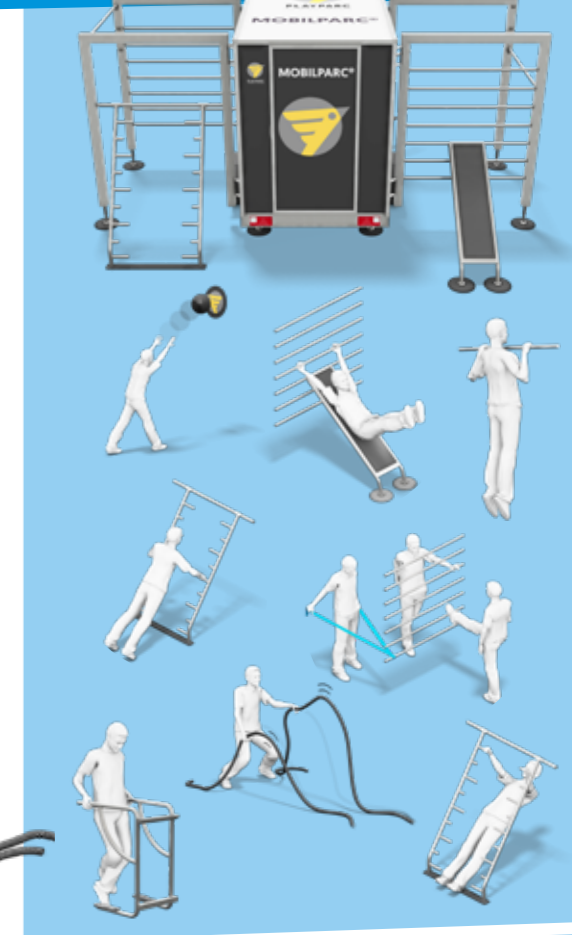

Dein innovativer Fitness-Trailer **MOBILPARC®** ist überall schnell aufgebaut und einsatzbereit. Die mobile Lösung für Outdoor-Fitness und Calisthenics überzeugt durch die standfeste, robuste Konstruktion und vielfältige Trainingsmöglichkeiten auf 360°. Errichte in kurzer Zeit eine mobile Fitnessanlage, in der alle Muskelgruppen an der frischen Luft, an jedem beliebigen Ort und zu jeder Zeit trainiert werden können.

In Kursen, bei Veranstaltungen und beim Gruppentraining bietet das Outdoor-Gym je nach Ausstattung und sportlichem Zubehör bis zu 15 Teilnehmer gleichzeitig die Möglichkeit, ein Maximum an Trainingserfolg zu erreichen.

Die Ausstattung und Größe des **MOBILPARC®** variieren nach Kundenwunsch.

Your innovative fitness trailer **MOBILPARC®** is set up quickly and ready for use wherever you are. The mobile solution for outdoor fitness and Calisthenics convinces with a stable, robust construction and a variety of training possibilities on 360°. Set up a mobile outdoor fitness station in a short time, in which all muscle groups can be trained in the fresh air, at every location and at all times.

Depending on the equipment and sporting accessories, the outdoor gym offers up to 15 users simultaneously the opportunity to achieve a maximum of training success in courses and at events.

The equipment and size of the **MOBILPARC®** vary according to customer requirements.





READY TO MOVE PARC

Die Parkourpioniere Martin Gessinger und Ben Scheffler haben ihre 15 Jahre Erfahrung in die Gestaltung der Ready-to-move-Parkouranlagen (RTM) einfließen lassen. Der Anspruch der RTM-Anlagen ist es Orte für Parkour zu schaffen, die unabhängig vom Können der Traceure über viele Jahre attraktiv sind.

Parkour pioneers Martin Gessinger and Ben Scheffler have put their 15 years of experience into the design of the ready-to-move (RTM) parkour facilities. The claim of the RTM facilities is to create places for parkour that are attractive for many years, regardless of the skill level of the traceurs.

ready to move designed by TraceSpace ist ein echter „game changer“ in der Welt von Parkourparks und Bewegungsräumen. Durch die modulare Bauweise und die Verwendung von Fertigbauteilen können wir schlüsselfertige Konzepte mit kürzester Bauzeit Realität werden lassen.

ready to move bietet eine branchenweit einzigartige Qualität und Konzeption:

- Ästhetisches und funktionelles Design
- Geplant von deutschen Parkourpionieren
- Ideal aufeinander abgestimmte Hindernisse/Geräte/Module
- Multiperspektivische Gestaltung
- Attraktiv für Parkour, Calisthenics, Fitness, Spiel & Spass
- Speziell für Parkour entwickelte Oberflächen bei Beton & Stahl mit herausragender Qualität
- Individuelle Gestaltungsoptionen nach Kundenwunsch

ready to move designed by TraceSpace is a real „game changer“ in the world of parkour parks and movement spaces. Modular construction and the use of prefabricated components allow us to make turnkey concepts a reality with the shortest construction time.

ready to move offers a quality and conception that is unique in the industry:

- Aesthetic and functional design
- Planned by German parkour pioneers.
- Ideally coordinated obstacles/equipment/modules
- Multi-perspective design
- attractive for parkour, calisthenics, fitness, fun & games
- Surfaces specially developed for Parkour in concrete & steel
- with outstanding quality
- Individual design options according to customer wishes

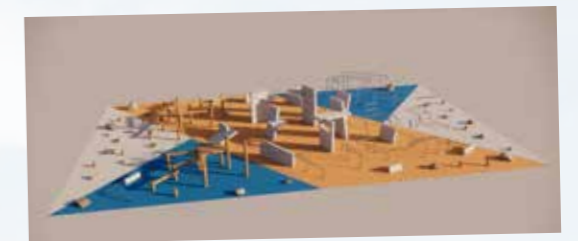

XL - 600m²

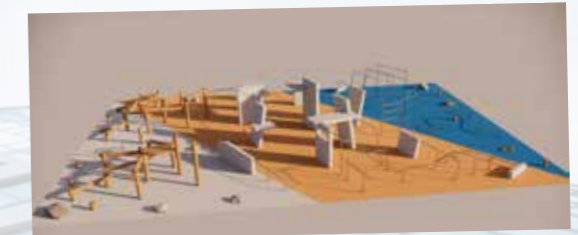

L - 450m²



M - 300m²



S - 150m²



OCR (Obstacle Course Racing) sind Extrem-Hindernisläufe, bei denen verschiedenartige Hindernisse in kurzer Zeit überwunden werden müssen. Dabei werden Kraft, Ausdauer, Beweglichkeit, Schnelligkeit, Geschicklichkeit, Balance und Koordination gefördert und trainiert. Mit starren oder beweglichen Hinderniselementen aus langlebigem Holz, Stahl und Netzstrukturen baut PLAYPARC alle OCR-Parks genau nach den Bedürfnissen und Anforderungen des Kunden.

OCR (Obstacle Course Racing) are extreme obstacle courses in which various obstacles have to be mastered in a short time. Strength, endurance, agility, speed, dexterity, balance and coordination are promoted and trained. With rigid or movable obstacle elements made of durable wood, steel and net structures, PLAYPARC builds all OCR parks exactly according to the customer's needs and requirements.



Alle OCR-Module sind neben der Basis-Version aus feuerverzinktem Stahl auch zusätzlich pulverbeschichtet (RAL-Farben) erhältlich.

RAL5015 **RAL1016** **RAL6017** **RAL2005** **RAL3002** **RAL9017**

Sonderfarben auf Anfrage / special colors on request

All OCR modules are optionally available with powder-coated steel (RAL colors) in addition to the basic galvanized steel version.



OCR OVER AND UNDER
12.03.200



OCR ROPE CLIMB
12.03.300.001



OCR WHEEL RUN 3M
12.03.050



OCR JUMP HANG
12.03.210



OCR HANGING ROPES
12.03.023



OCR TURNING WHEEL
12.03.020



OCR HANGING RINGS
12.03.025



OCR ANGLED STEPS
12.03.090

Zur Gestaltung von spannenden OCR-Strecken bieten sich diverse weitere Artikel aus dem Produktportfolio von PLAYPARC als anwechslungsreiche Hindernisse an.

For the design of exciting OCR routes, various other items from the PLAYPARC product portfolio offer themselves as diversified obstacles.

FEDERBALANCIERBALKEN
SPRING BALANCE BEAM
12.05.010



DREHBALKEN
ROLLING BALANCE BEAM
12.05.015



SLACKLINE 4M
06.01.045



4FCIRCLE® HANGELLEITER
12.04.026



4FCIRCLE® SPIDER NET
12.04.031



OCR CLIMBING NET-WALL
12.03.301,001



OCR HANGING WIRE
12.03.024



OCR DOUBLE CLIMB
12.03.021



OCR WALL RUN
12.03.022





Beispielhafter Auszug aus dem neuen URBANPARC®-Programm. Entdecken Sie mehr unter www.urbanparc.de!



Sample selection from the new URBANPARC® program. Discover more at www.urbanparc.de!



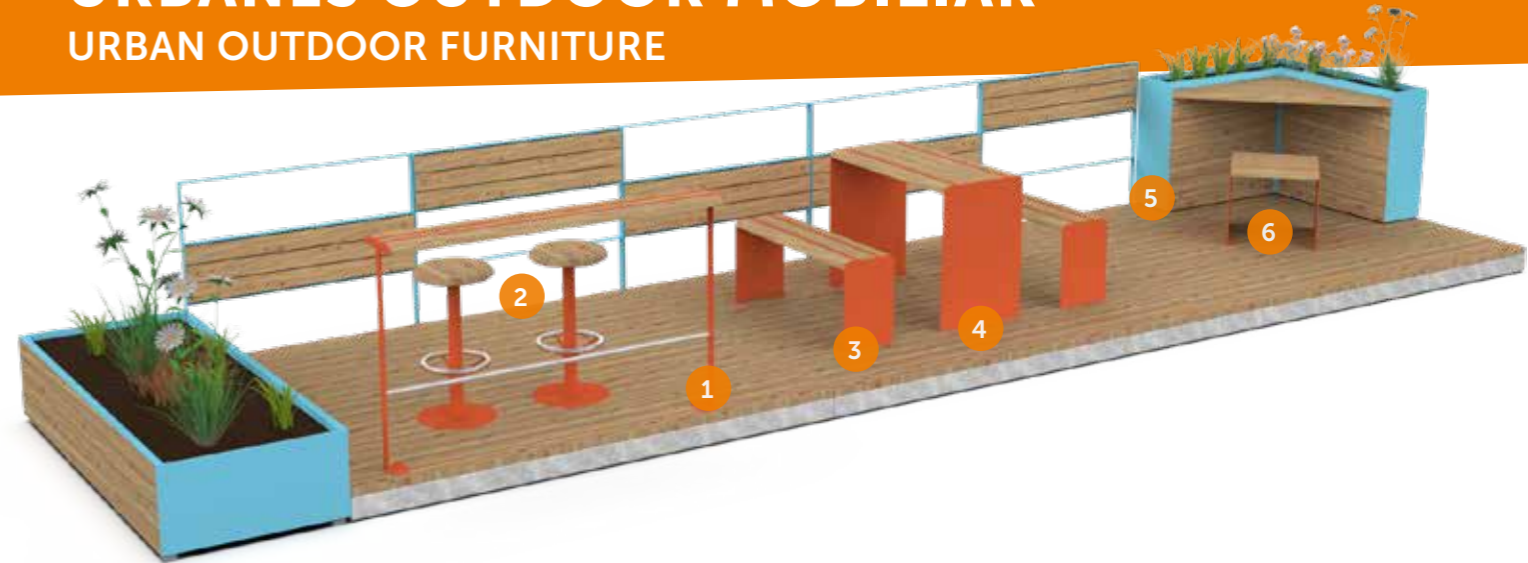

- 1 CITY CLUB STEHTISCH**
HIGH TABLE
14.02.514
⊕ 1,00 x 0,25 x 1,00 m
- 2 CITY CLUB BARHOCKER**
BAR STOOL
14.02.503
⊕ Ø 0,36 m ⊕ 0,70 m
- 3 CITY CLUB HOCKER-BANK**
BENCH w/o rest
14.02.501
⊕ 1,6 x 0,45 x 0,45 m
- 4 CITY CLUB TISCH**
TABLE
14.02.513
⊕ 1,6 x 0,60 x 0,75 m
- 5 CITY CLUB BEET MIT TISCH 1**
PLANT BED TABLE 1
14.02.512
⊕ 1,00 x 1,00 x 0,80 m
- 6 CITY CLUB HOCKER**
STOOL w/o rest
14.02.502
⊕ 0,50 x 0,45 x 0,45 m



CITY CLUB PARKBANK
PARK BENCH
14.02.504
⊕ 1,60 x 0,60 x 0,80 m



CITY CLUB PLATEAU
14.02.894
⊕ 6,25 x 5,00 x 0,90 m



SITZQUADRAT MIT LEHNE UND BEET
SEATING SQUARE W. REST / PLANT BED

14.02.898

⊕ 1,95 x 1,95 x 0,90 m /

0,45 m SITZHÖHE SEATING HEIGHT



RUNDBEET-BANK
ROUND PLANT BED

14.02.892

⊕ Ø 2,20 ⊞ 0,86 m

0,45 m SITZHÖHE SEATING HEIGHT



WETTERSCHUTZ REFUGIO

RAIN SHELTER REFUGIO

14.02.892

⊕ Ø 2,20 ⊞ 0,86 m

0,45 m SITZHÖHE SEATING HEIGHT





GABI SITZGRUPPE GABI SEATING GROUP

14.02.120
⊕ 2,00 x 1,31 x 0,73 m ⊕ 0,73 m



14.02.120.005
⊕ 3,00 x 1,31 x 0,73 m ⊕ 0,73 m



GABI BANK OHNE LEHNE GABI BENCH WITHOUT BACKREST

14.02.123
⊕ 2,00 x 0,30 x 0,42 m ⊕ 0,42 m



GABI BANK MIT LEHNE GABI BENCH WITH BACKREST

14.02.122
⊕ 2,00 x 0,56 x 0,47 m ⊕ 0,47 m

GABI TISCH GABI TABLE

14.02.121
⊕ 2,00 x 0,51 x 0,72 m ⊕ 0,73 m



GABI SEATING GROUP INKLUSION GABI SEATING GROUP INCLUSION

14.02.120.004
⊕ 2,50 x 1,31 x 0,83 m ⊕ 0,83 m



SITZGRUPPE WARBURG SEATING ARRANGEMENT WARBURG

14.02.125 SITZGRUPPE MIT TISCH UND BANK
SEATING WITH TABLE AND BENCH

⊕ 3,52 x 3,11 x 0,85 m

14.02.126 MIT 3 HOCKERN WITH 3 STOOLS

⊕ 3,52 x 3,11 x 0,85 m

14.02.127 SITZHOCKER EINZELN SINGLE STOOL

⊕ 0,40 x 0,40 x 0,45 m



HEIDI SEATING GROUP HEIDI SEATING GROUP*

14.02.113
⊕ 2,00 x 1,54 x 0,70 m
⊕ 0,7 m



HEIDELORE PICKNICKBANK HEIDELORE PICKNICK BENCH

14.02.110
⊕ 2,00 x 1,54 x 0,70 m
⊕ 0,70 m



RELAXING

14.02.150
⊕ 1,48 x 1,60 x 1,14 m ⊕ 1,14 m





LUISA MIT RÜCKENLEHNE
LUISA WITH BACK REST
14.02.453
⊕ 1,81 x 0,75 x 0,41 m



EMILIA STANDARD SESSEL
14.02.447
⊕ 0,70 x 0,60 x 0,79 m



EMILIA PC
14.02.302
⊕ 1,80 x 0,79 x 0,62 m



EMILIA STANDARD
14.02.301
⊕ 1,80 x 0,63 x 0,79 m



LEA OHNE RÜCKENLEHNE
LEA WITHOUT BACK REST
14.02.324
⊕ 2,00 x 0,43 x 0,65 m



PAPANERA 2
14.02.330
⊕ 0,51 x 0,33 x 1,03 m



FAHRRADSTÄNDER BARCELONA
BICYCLE STAND BARCELONA
14.02.402
⊕ 0,75 x 0,99 m



MIRA
14.02.445
⊕ 2,09 x 0,89 x 0,68 m



LARA STANDARD
14.02.406
⊕ 2,00 x 0,45 x 0,49 m



PAPANERA 16
14.02.345
⊕ 0,43 x 0,39 x 1,32 m



FAHRRADSTÄNDER KOPENHAGEN
BICYCLE STAND COPENHAGEN
14.02.400
⊕ 1,80 x 0,48 x 0,37 m





ALLGEMEINE GESCHÄFTSBEDINGUNGEN

1. Allgemeines

1.1. Sämtliche Geschäftsbeziehungen zwischen der PLAY-PARC Allwetter-Freizeit-Anlagenbau GmbH, Teutonia 9, 34439 Willebadessen, vertreten durch den Geschäftsführer, Siegfried Strasser, (nachfolgend auch „Verkäufer“ oder „PLAYPARC“ genannt) und dem Kunden (nachfolgend auch „Besteller“ genannt) unterliegen den nachfolgenden Allgemeinen Geschäftsbedingungen in ihrer zum Zeitpunkt der Bestellung gültigen Fassung.

1.2. Der Vertragstext wird vom Verkäufer gespeichert, der Kunde kann diese Allgemeinen Geschäftsbedingungen über die Menüführung des Browsers bzw. mittels Tastaturkombination (Strg p, Strg s) drucken bzw. lokal auf seinem PC speichern.

1.3. Die Geschäftsbeziehungen unterliegen dem Recht der Bundesrepublik Deutschland unter Ausschluss des UN-Kaufrechts. Die Vertragssprache ist deutsch.

1.4. Gerichtsstand ist Paderborn, soweit der Kunde Kaufmann ist oder eine juristische Person des öffentlichen Rechts oder öffentlich-rechtliches Sondervermögen.

2. Vertragsschluss

2.1. Der Verkäufer bietet den Kunden in seinem Online-Shop unter www.PLAYPARC.de oder seine gedruckten Kataloge Produkte zum Kauf an. Die Darstellung der Produkte im Katalog bzw. Online-Shop stellt kein rechtlich bindendes Angebot, sondern einen unverbindlichen Online-Katalog bzw. Katalog dar.

2.2. Die Bestellung des Kunden stellt ein Angebot an die PLAYPARC zum Abschluss eines Kaufvertrags dar. Nach Eingang der Bestellung wird PLAYPARC den Kunden über den Eingang seiner Bestellung schriftlich informieren (Bestellbestätigung per Email, Auftragsbestätigung per Fax, oder Post). Die Bestellbestätigung stellt keine Annahme des Angebots des Bestellers dar. Der Kaufvertrag kommt mit Annahme des Angebots durch die PLAYPARC zustande. Die Annahme erfolgt durch die Lieferung der Ware. Im Onlineshop gibt der Kunde durch Anklicken des Buttons „Kauf abschließen“ eine verbindliche Bestellung der im Warenkorb enthaltenen Waren ab. Eingabefehler können vor Absenden der Bestellung mittels der üblichen Tastatur- und Mausfunktionen berichtigt werden.

3. Preise, Kosten

Es gelten die Preise zum Zeitpunkt der Bestellung. Alle Preise verstehen sich zzgl. der jeweils gültigen deutschen gesetzlichen Mehrwertsteuer und zuzüglich der Versandkosten. Für unsere Kunden, die Unternehmer sind, enthalten unsere übersandten Kataloge Netto-Preise ab Werk.

4. Zahlungsbedingungen

Der Kaufpreis ist innerhalb 14 Tagen nach Abzug eventueller Rabatte plus gesetzl. MwSt. rein netto auf das in der Rechnung angegebene Konto zu leisten. Frachten, Montagen etc. sind weder Rabatt noch Skontierfähig.

Unsere Forderungen sind im Zuge des Factoringverfahrens verkauft und abgetreten. Schuld-befreiende Zahlung ist deshalb auf das Konto der CB Credit-Bank GmbH möglich. Sollten Sie Vorauskasse leisten oder Ihren Rechnungsanschrift-Sitz außerhalb der BRD haben, erfolgen

Zahlungen auf unser Sparkassenkonto.

5. Lieferung, Versandkosten

5.1. Lieferungen an die vom Besteller angegebene Lieferadresse innerhalb von 25 Werktagen ab Bestellung durch den Kunden oder individuell festgelegt.

5.2. Je Auftrag fallen nur einmal Versandkosten an. Die Versandkosten innerhalb Deutschlands betragen pauschal 13% des Nettowarenwertes. Beträgt der Auftragswert allerdings weniger als 100,- EURO Nettowarenwert, betragen die Versandkosten pauschal 13,- EURO. Die Versandkosten innerhalb der EU betragen pauschal 18% des Nettowarenwertes. Beträgt der Auftragswert allerdings weniger als 100,- EURO Nettowarenwert, betragen die Versandkosten pauschal 18,- EURO.

5.3. Eine Selbstabholung durch den Besteller ist nach Absprache ab Lager möglich. In diesem Fall entfallen die Versandkosten.

5.4. Ist der Kunde Unternehmer, ist Lieferung „ab Werk“ vereinbart. Sofern der Kunde es wünscht, werden wir die Lieferung durch eine Transportversicherung eindecken; die insoweit anfallen Kosten trägt der Kunde.

6. Eigentumsvorbehalt

6.1. Die gelieferte Ware verbleibt bis zur vollständigen Zahlung des Kaufpreises im Eigentum der PLAYPARC.

6.2. Ist der Kunde Unternehmer muss dieser uns bei Pfändungen oder sonstigen Eingriffen Dritter unverzüglich schriftlich zu benachrichtigen.

6.3. Der Kunde ist berechtigt, die Kaufsache im ordentlichen Geschäftsgang weiter zu verkaufen; er tritt uns jedoch, wenn er Unternehmer ist, bereits jetzt alle Forderungen in Höhe des Faktura-Endbetrages (einschließlich MwSt) unserer Forderung ab, die ihm aus der Weiterveräußerung gegen seine Abnehmer oder Dritte erwachsen, und zwar unabhängig davon, ob die Kaufsache ohne oder nach Verarbeitung weiter verkauft worden ist. Zur Einziehung dieser Forderung bleibt der Kunde auch nach der Abtretung ermächtigt. Unsere Befugnis, die Forderung selbst einzuziehen, bleibt hiervon unberührt. Wir verpflichten uns jedoch, die Forderung nicht einzuziehen, solange der Kunde seinen Zahlungsverpflichtungen aus den vereinnahmten Erlösen nachkommt, nicht in Zahlungsverzug gerät und insbesondere kein Antrag auf Eröffnung eines Vergleichs- oder Insolvenzverfahrens gestellt ist oder Zahlungseinstellung vorliegt. Ist aber dies der Fall, so können wir verlangen, dass der Kunde uns die abgetretenen Forderungen und deren Schuldner bekannt gibt, alle zum Einzug erforderlichen Angaben macht, die dazugehörigen Unterlagen aushändigt und den Schuldnern (Dritten) die Abtretung mitteilt.

6.4. Wir verpflichten uns, die uns zustehenden Sicherheiten auf Verlangen des Kunden insoweit freizugeben, als der realisierbare Wert unserer Sicherheiten die zu sichernden Forderungen um mehr als 10% übersteigt; die Auswahl der freizugebenden Sicherheiten obliegt uns.

ALLGEMEINE GESCHÄFTSBEDINGUNGEN

7. Gewährleistung

7.1. Es gelten die gesetzlichen Vorschriften.

7.2. Für Unternehmer beträgt bei neuen Waren die Verjährungsfrist für Mängel ein Jahr ab Gefahrübergang. Die vorstehenden Abweichungen von der gesetzlichen Mängelhaftungsverjährungsfrist gelten nicht, wenn der Verkäufer wegen grober Fahrlässigkeit und / oder Vorsatzes haftet. Unberührt davon bleiben ebenso Ansprüche wegen Verletzung von Leben, Körper oder Gesundheit aufgrund eines Mangels. Im übrigen gilt § 9 dieser AGB.

7.3. Die Abnahme hat unverzüglich nach Fertigstellung, vollständiger Lieferung bzw. gesonderter Aufforderung zu erfolgen. Offensichtliche Mängel sind innerhalb von 10 Tagen nach Erhalt der Lieferung, andere Mängel unverzüglich nach Entdeckung schriftlich zu rügen. Der Auftraggeber darf Zahlungen wegen berechtigter Mängel nur in angemessenem Verhältnis zum Wert des mangelhaften Liefergegenstandes zurückhalten. Es wird keine Gewähr übernommen für Schäden, die aus nachfolgenden Gründen entstanden sind: Ungeeignete oder unsachgemäße Verwendung, fehlerhafte Montage bzw. Inbetriebsetzung durch den Auftraggeber oder Dritte, natürliche Abnutzung, fehlerhafte oder nachlässige Behandlung, ungeeignete Betriebsmittel, mangelhafte Bauarbeiten sowie außergewöhnliche äußere Einflüsse, sofern sie nicht auf ein Verschulden des Auftragnehmers zurückzuführen sind. Entsprechendes gilt für Änderungen oder Instandsetzungsarbeiten des Auftraggebers oder Dritter, die unsachgemäß ohne vorherige Zustimmung des Auftragnehmers vorgenommen wurden.

7.4. Zur Vornahme aller nach billigem Ermessen notwendig erscheinenden Nachbesserungen und Ersatzlieferungen hat der Auftraggeber nach Verständigung mit dem Auftragnehmer die erforderliche Zeit und Gelegenheit zu geben, sonst ist der Auftragnehmer von der Mängelhaftung befreit. Nur in dringenden Fällen der Gefährdung der Betriebssicherheit und zur Abwehr unverhältnismäßig großer Schäden, wobei der Auftragnehmer zu verständigen ist, oder wenn der Auftragnehmer mit der Beseitigung des Mangels im Verzug ist, hat der Auftraggeber das Recht, den Mangel selbst oder durch Dritte beseitigen zu lassen und vom Auftragnehmer Ersatz der notwendigen Kosten zu verlangen.

7.5. Läßt der Auftragnehmer eine ihm gesetzte angemessene Nachfrist verstreichen, ohne den Mangel behoben oder Ersatz geliefert zu haben, so ist der Auftraggeber berechtigt, Rückgängigmachung des Vertrages zu verlangen. Sofern eine Bauleistung Gegenstand der Gewährleistung ist, kann der Auftraggeber nur Herabsetzung des Preises verlangen.

7.6. Schadenersatzansprüche aus Verzug, aus Unmöglichkeit der Leistung, aus schuldhafter Verletzung vertraglicher Nebenpflichten, aus Verschulden bei Vertragsschluß und aus unerlaubter Handlung werden ausgeschlossen, es sei denn, sie beruhen auf Vorsatz oder grober Fahrlässigkeit. Für Vorsatz und grobe Fahrlässigkeit nicht leitender Erfüllungsgehilfen wird nur gehaftet, wenn sie eine wesentliche Vertragspflicht verletzen. Der Haftungsausschluß gilt ferner nicht beim Fehlen ausdrücklich zugesicherter Eigenschaften, wenn die Zusicherung gerade bezweckt, den Auftraggeber gegen Schäden abzusichern, die nicht am Liefergegenstand selbst entstanden sind. Die Haftung wird auch für grob fahrlässige Verletzungen auf den Ersatz des zum Zeitpunkt des Vertragsabschlusses voraussehbaren Schadens begrenzt.

7.7. Ansprüche wegen Körperschäden und Schäden an privatgenutzten Sachen nach dem

Produkthaftungsgesetz bleiben hiervon unberührt.

8. Haftungsbeschränkung

8.1. Bei leicht fahrlässigen Pflichtverletzungen beschränkt sich die Haftung des Verkäufers auf den vorhersehbaren, vertragstypischen, unmittelbaren Durchschnittsschaden. Dies gilt auch bei leicht fahrlässigen Pflichtverletzungen seiner Erfüllungsgehilfen.

8.2. Gegenüber Unternehmern haftet der Auftragnehmer bei leicht fahrlässiger Verletzung unwesentlicher Vertragspflichten nicht.

8.3. Die Haftung für arglistiges Verschweigen eines Mangels, für die Übernahme einer Garantie für die Beschaffenheit oder Haltbarkeit der Ware bleibt von den vorstehenden Bedingungen unberührt.

8.4. Die vorstehenden Haftungsbeschränkungen betreffen nicht Ansprüche des Kunden aus Produkthaftung. Weiter gelten die Haftungsbeschränkungen nicht bei zurechenbaren Körper- und Gesundheitsschäden oder zurechenbarem Verlust des Lebens des Kunden.

8.5. Weitere Schadenersatzansprüche sind ausgeschlossen, insbesondere der Ersatz mittelbarer Schäden und Schäden, die aufgrund höherer Gewalt, d.h. unvorhersehbare unabwendbare Ereignisse eintreten.

9. Datenschutz

Gemäß § 28 BDSG (Bundesdatenschutzgesetz) macht PLAYPARC Sie darauf aufmerksam, dass die im Rahmen der Geschäftsabwicklung notwendigen Daten mittels einer EDV-Anlage verarbeitet und gespeichert werden. Sämtliche vom Kunden erhobenen personenbezogenen Daten werden vertraulich und entsprechend der gesetzlichen Regelungen behandelt. Der Kunde hat jederzeit ein Recht auf kostenlose Auskunft, Berichtigung, Sperrung und Löschung seiner gespeicherten Daten gem. §§ 34, 35 BDSG. Senden Sie dazu eine E-Mail mit dem Betreff „Datenschutz“.

10. Salvatorische Klausel

Sind oder werden einzelne Bestimmungen dieser Allgemeinen Geschäftsbedingungen und/oder des durch sie ergänzten Vertrages unwirksam, so wird dadurch die Wirksamkeit der anderen Bestimmungen nicht berührt.

11. Anbieterkennzeichnung

PLAYPARC · Zur Kohlstätte 9 · D-33014 Bad Driburg
E-Mail: info@playparc.de
Tel: +49 (0) 52 53/4 05 99-0 · Fax: 4 05 99-10

Vertretungsberechtigter Geschäftsführer: Siegfried Strasser
Handelsregister: Amtsgericht Paderborn – HRB 4951
Umsatzsteuer-ID: DE126711847



GENERAL TERMS AND CONDITIONS OF BUSINESS

1. General

1.1. All business relations between PLAYPARC Allwetter-Freizeit-Anlagenbau GmbH, Zur Kohlstätte 9, D-33014 Bad Driburg-Siebenstern, represented by the managing director, Siegfried Strasser, (hereinafter also referred to as „seller“ or „PLAYPARC“) and the customer (hereinafter also referred to as „customer“) are subject to the following General Terms and Conditions in the version valid at the time of the order.

1.2. The contract text is stored by the seller, the customer can print these terms and conditions via the menu navigation of the browser or by means of keyboard combination (Ctrl p, Ctrl s) or store locally on his PC.

1.3. The business relations are subject to the law of the Federal Republic of Germany to the exclusion of the UN Convention on Contracts for the International Sale of Goods. The contract language is German.

1.4. The place of jurisdiction shall be Paderborn if the customer is a merchant or a legal entity under public law or a special fund under public law.

2. Conclusion of contract

2.1. The seller offers the customer products for sale in his online shop at www.PLAYPARC.de or his printed catalogues. The presentation of the products in the catalogue or online shop is not a legally binding offer, but a non-binding online catalogue or catalogue.

2.2. The customer's order constitutes an offer to PLAYPARC to conclude a sales contract. After receipt of the order PLAYPARC will inform the customer about the receipt of his order in writing (order confirmation by email, order confirmation by fax, or mail). The order confirmation does not constitute an acceptance of the customer's offer. The purchase contract is concluded with the acceptance of the offer by PLAYPARC. Acceptance shall be affected by delivery of the goods. In the online shop, the customer places a binding order for the goods contained in the shopping basket by clicking the „Complete purchase“ button. Input errors can be corrected before sending the order using the usual keyboard and mouse functions.

3. Prices, costs

The prices at the time of the order apply. All prices are exclusive of the applicable German value added tax and plus shipping costs. For our customers who are entrepreneurs, our sent catalogues contain net prices ex works.

4. Terms of payment

The purchase price is to be paid within 14 days after deduction of possible discounts plus VAT net to the account stated in the invoice. Freight, assembly etc. are neither discountable nor discountable.

Our receivables have been sold and assigned in the course of the factoring procedure. Debt-discharging payment is therefore possible to the account of CB Credit-Bank GmbH. If you pay in advance or have your billing address outside Germany, payments will be made to our savings bank account

5. Delivery, shipping costs

5.1. Deliveries to the delivery address specified by the customer within 25 working days of the order being placed by the customer or individually determined.

5.2. Each order is subject to only one delivery charge. The shipping costs within Germany amount to 13% of the net value of the goods. However, if the order value is less than 100,- EURO net goods value, the shipping costs are a flat rate of 13,- EURO. The shipping costs within the EU amount to 18% of the net value of the goods. However, if the order value is less than 100,- EURO net goods value, the shipping costs are a flat rate of 18,- EURO.

5.3. The customer may collect the goods himself from the warehouse by arrangement. In this case the forwarding expenses are void.

5.4. If the customer is an entrepreneur, delivery „ex works“ is agreed. If the customer so wishes, we shall cover the delivery with transport insurance; the costs incurred in this respect shall be borne by the customer.

6. Retention of title

6.1. The delivered goods remain the property of PLAYPARC until the purchase price has been paid in full.

6.2. If the customer is an entrepreneur, he must inform us immediately in writing of any attachments or other interventions by third parties.

6.3. The customer shall be entitled to resell the object of sale in the ordinary course of business; however, if he is an entrepreneur, he hereby assigns to us all claims in the amount of the final invoice amount (including VAT) of our claim accruing to him from the resale against his customers or third parties, irrespective of whether the object of sale has been resold without or after processing. The customer remains authorised to collect this claim even after the assignment. Our authority to collect the claim ourselves remains unaffected by this. However, we undertake not to collect the claim as long as the customer meets his payment obligations from the proceeds received, is not in default of payment and, in particular, no petition has been filed for the opening of composition or insolvency proceedings and payments have not been suspended. If this is the case, however, we can demand that the customer informs us of the assigned claims and their debtors, provides all information necessary for collection, hands over the relevant documents and informs the debtors (third parties) of the assignment.

6.4. We undertake to release the securities to which we are entitled at the customer's request insofar as the realisable value of our securities exceeds the claims to be secured by more than 10%; the choice of the securities to be released shall be incumbent on us.

GENERAL TERMS AND CONDITIONS OF BUSINESS

7. Warranty

7.1. The statutory provisions shall apply.

7.2. For entrepreneurs, the limitation period for defects in new goods shall be one year from the passing of risk. The above deviations from the statutory limitation period for liability for defects shall not apply if the Seller is liable due to gross negligence and/or intent. Claims due to injury to life, body or health due to a defect shall also remain unaffected. In all other respects § 9 of these General Terms and Conditions shall apply.

7.3. Acceptance shall take place immediately after completion, complete delivery or separate request. Obvious defects must be reported in writing within 10 days of receipt of the delivery, other defects must be reported immediately after discovery. The customer may withhold payments due to justified defects only in a reasonable proportion to the value of the defective delivery item. No liability is assumed for damages resulting from the following reasons: Unsuitable or improper use, faulty assembly or commissioning by the customer or third parties, natural wear and tear, faulty or negligent treatment, unsuitable operating materials, defective construction work and unusual external influences, insofar as they are not attributable to the fault of the contractor. The same shall apply mutatis mutandis to modifications or repair work carried out by the Customer or third parties which were carried out improperly without the prior consent of the Contractor.

7.4. In order to carry out all rectifications and replacement deliveries which appear necessary at reasonable discretion, the Customer shall, after consultation with the Contractor, give the necessary time and opportunity, otherwise the Contractor shall be released from liability for defects. Only in urgent cases of danger to operational safety and to prevent disproportionately large damage, in which case the Contractor shall be notified, or if the Contractor is in default of remedying the defect, shall the Customer have the right to remedy the defect itself or have it remedied by third parties and to demand reimbursement of the necessary costs from the Contractor.

7.5. If the Contractor allows a reasonable grace period set for him to expire without having remedied the defect or supplied a replacement, the Client shall be entitled to demand rescission of the contract. If a construction service is subject to warranty, the client can only demand a reduction of the price.

7.6. Claims for damages arising from delay, impossibility of performance, culpable breach of contractual accessory obligations, culpa in contrahendo and tort shall be excluded unless they are based on intent or gross negligence. For intent and gross negligence of non-executive vicarious agents, liability shall only be assumed if they violate an essential contractual obligation. The exclusion of liability shall also not apply in the absence of expressly warranted characteristics if the purpose of the warranty is precisely to protect the customer against damage which has not occurred to the delivery item itself. Liability shall also be limited for grossly negligent breaches to compensation for the damage foreseeable at the time of conclusion of the contract.

7.7. Claims due to bodily injury and damage to privately used items in accordance with the Product Liability Act shall remain unaffected.

8. Limitation of liability

8.1. In the case of slightly negligent breaches of duty, the Seller's liability shall be limited to the foreseeable, contract-typical, direct average damage. This also applies to slightly negligent breaches of duty by its vicarious agents.

8.2. The Contractor shall not be liable to entrepreneurs for slightly negligent breach of insignificant contractual obligations.

8.3. Liability for fraudulent concealment of a defect, for the assumption of a guarantee for the quality or durability of the goods shall remain unaffected by the above conditions.

8.4. The above limitations of liability do not apply to claims of the customer arising from product liability. Furthermore, the limitations of liability shall not apply in the case of attributable physical injury and damage to health or attributable loss of life of the customer.

8.5. Further claims for damages are excluded, in particular compensation for indirect damages and damages that occur due to force majeure, i.e. unforeseeable unavoidable events.

9. Data protection

According to § 28 BDSG (Federal Data Protection Act) PLAYPARC draws your attention to the fact that the data necessary in the context of the business transaction are processed and stored by means of an EDP system. All personal data collected from the customer will be treated confidentially and in accordance with the statutory regulations. The customer has at any time the right to free information, correction, blocking and deletion of his stored data according to §§ 34, 35 BDSG. Please send us an e-mail with the subject „Privacy“.

10. Severability clause

If individual provisions of these General Terms and Conditions and/or the contract supplemented by them are or become invalid, this shall not affect the validity of the other provisions.

11. Provider identification

PLAYPARC
Zur Kohlstätte 9
D-33014 Bad Driburg
E-Mail: info@playparc.de
Tel: +49 (0) 52 53/4 05 99-0
Fax: +49 (0) 52 53/4 05 99-10

Managing Director: Siegfried Strasser
Commercial Register: Paderborn Local Court – HRB 4951
Value Added Tax: DE126711847



ERWEITERTE GEWÄHRLEISTUNGEN

EXTENDED WARRANTIES

Gewährleistungen

Die Gewährleistungsfrist beginnt mit dem Datum der Anlieferung und beträgt für unterschiedliche Produktgruppen (Geräteteile) wie folgt:

- 10 Jahre** auf Korrosionsschäden bei Edelstahl und feuerverzinkten Stahlkonstruktionen, welche die Standsicherheit und Funktion beeinträchtigen. Ausgenommen sind Umwelteinflüsse und chemische Reaktionen, die von anderen Metallen verursacht werden.
- 8 Jahre** auf kesseldruckimprägnierte Hölzer mit Pfostenschuhen gegen Bruch und Fäulnisschäden, welche die Standsicherheit beeinträchtigen.
- 5 Jahre** auf Bruch bei allen PE-Elementen, auf Taue und Netze mit Stahleinlage
- 2 Jahre** auf alle beweglichen Teile und GFK-Rutschen

Gewährleistung bezieht sich auf Materialmängel, auf Verarbeitungsmängel und auf die Standsicherheit der Geräte bei fachgerechtem Einbau.

Ausgenommen von der Gewährleistung sind, soweit gesetzlich möglich:

- Schäden, die aufgrund einer nicht fachgerechten Montage erfolgen (nicht gemäß unseren Montageanleitungen)
- witterungsbedingte Trockenrisse im Holz unter 8 mm (vgl. Beiblatt DIN EN 1776)
- Schäden, die durch mutwillige Zerstörung und Vandalismus entstanden sind
- Schäden, die auf vermehrten Pilzbefall zurückzuführen sind, weil die Geräte unter Bäumen oder Sträuchern stehen, welche einen solchen Pilzbefall verursachen
- Schäden an hölzernen Standpfosten mit Pfostenschuhen, die durch Erdkontakt oder Kontakt mit Rindenmulch entstanden sind
- Schäden, die durch mangelnde Wartung entstehen
- Schäden an Elementen, die dem nutzungsbedingten Verschleiß unterliegen. Dies sind insbesondere Gelenke, Lager, Ketten, Seile, Netze und Laufflächen.

Voraussetzung für die Wirksamkeit der Gewährleistung ist die Wartung der Geräte durch geschultes Personal und nach Vorgaben der playparc GmbH, sowie im Bedarfsfall, die fachgerechte Reparatur.

Den Nachweis der regelmäßig durchgeführten, ordnungsgemäßen Wartung (Vorlage der vollständigen Kontroll- und Wartungsberichte nach Vorgaben der DIN EN 1176, Teil 7) führt der Auftraggeber bzw. der Betreiber der Geräte.

Weiterhin gelten die Bestimmungen zur Gewährleistung gemäß unseren allgemeinen Geschäftsbedingungen.

Warranties

The warranty term starts with the date of delivery and is valued for different durations for individual product groups/ equipment as follows:

- 10 years** Corrosion damage on stainless steel and zinc steel constructions, if there are risks to the supporting safety of the equipment.
- 8 years** High-pressure impregnated wood with pillar posts against breakings and damage by mould/rotting, if there are risks to the safety of the stable support of the equipment.
- 5 years** Breaking of all PE Elements, ropes and nets with steel inlays.
- 2 years** On all movable items and GFK-Slides.

These warranty clauses refer to faults in the material, faults in production and loss of stable support (provided the equipment has been installed correctly).

Not included in these warranty clauses are (as long as legally possible):

- Faults that have been caused by faulty/incorrect/insufficient installation (not according to our installation details)
- Damage/tears of dryness due to weather conditions in wood smaller than 8mm (EN1176)
- Damage that has been caused willingly by vandalism
- Damage due to fungus and mould that occurs due to installations in shady places under trees or close to bushes
- Damage to wooden supporting pillars with pillar posts, caused by contact with the soil or mulch
- Damage caused by lack of service/maintenance
- Damage to elements that have had high high wear andtear. which are mainly joints. bearings, chains. ropes, nets and walking treads.

Requirement for the validation of these warranty clauses are: services/maintenance to be carried out by trained personel and only according to the PLAYPARC GmbH installation information. as weil as if required, by professional repair service.

The proof for these services to be carried out regularly according to DIN EN1176, part 7) is to be provided by the contractor or the operator/owner of the equipment. In addition, the regulations of warranty are valid according to our current terms and conditions.

SIE HABEN FRAGEN ODER MÖCHTEN EINE BESTELLUNG AUFGEBEN?

KONTAKTIEREN SIE UNS!

YOU HAVE QUESTIONS OR WOULD LIKE TO ORDER SOMETHING? CONTACT US!



per Telefon by phone:

+49 (0)5253/40599-0

Mo.–Do. (Mo.–Th.) 8.00–16.15 Uhr
Fr. 8.00–13.00 Uhr



per Fax by fax:

+49 (0)5253/40599-10



per Internet by internet:

www.playparc.de



per mail by mail:

info@playparc.de

LIEFERUNG DELIVERY

- Lieferung innerhalb 2–6 Wochen nach Auftragsingang
- Delivery within 2-6 weeks after receipt of order

LIEFERKOSTEN DELIVERY COSTS

Fracht- und Verpackungskosten:

- **Innerhalb Deutschlands 13 %** vom Nettowarenwert, 13 € bei einem Nettowarenwert von unter 100,00 €
- **Innerhalb der EU 18 %** vom Nettowarenwert, 18 € bei einem Nettowarenwert von unter 100,00 €

Freight and packaging costs:

- **Within Germany 13 %** of the net goods value, 13 € with a net goods value of under 100,00 €
- **Within the EU 18 %** of the net goods value, 18 € with a net goods value of less than 100,00 €.

PREISE PRICES

- Preise verstehen sich ab Werk, zzgl. der gesetzlichen Mehrwertsteuer.
- Preise gelten innerhalb Deutschlands, Irrtümer vorbehalten.
- Da wir unsere Preise fair gestalten, gewähren wir keine Skontierung oder Rabatte.
- Zahlbar innerhalb von 14 Tagen

- Prices are quoted ex works; plus, statutory value added tax.
- Prices are valid within Germany, errors excepted.
- As we set our prices fairly, we do not grant any discounts or rebates.
- Discounts within 14 days